

37129 SIMRIT

Radial shaft seals

TYPE: Radial shaft seals, Metal case, With spring-loaded sealing lip, Type B1SL, material 72 NBR 902 (SIMRIT)

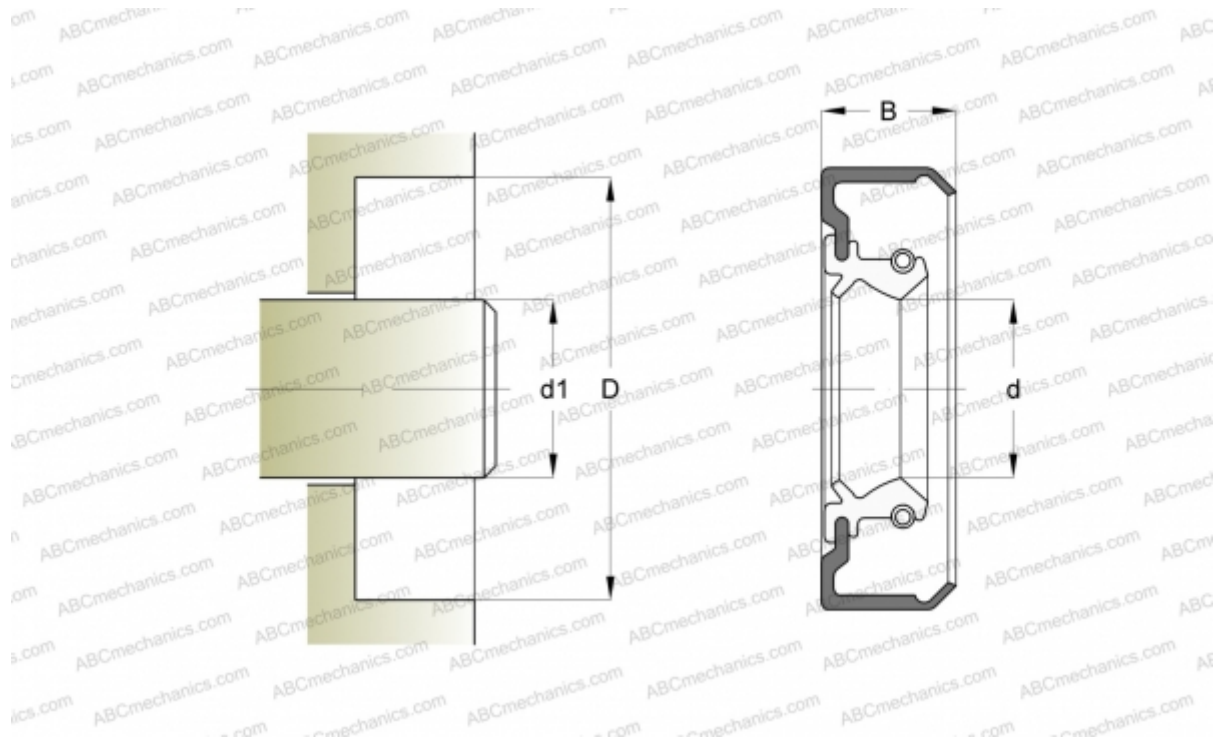

Technical specification

DIMENSIONS, MM

d1	170,000
d	170,000
D	200,000
B	12,000

MANUFACTURER

[SIMRIT](#)

CALCULATION DATA

Operating temperature min	-40 °C
Operating temperature max	100 °C
Permissible operating temperature, short periods max	120 °C
Pressure differential max	0,050 Mpa
Maximum shaft surface speed	10,000 m/s

REPLACES

B1SL 170-200-12 72 NBR 902 (37129)