

23265 SIMRIT

Radial shaft seals

TYPE: Radial shaft seals, Metal case and a secondary reinforcement in the side face, With spring-loaded sealing slip, Type B2U, material 72 NBR 902 (SIMRIT)

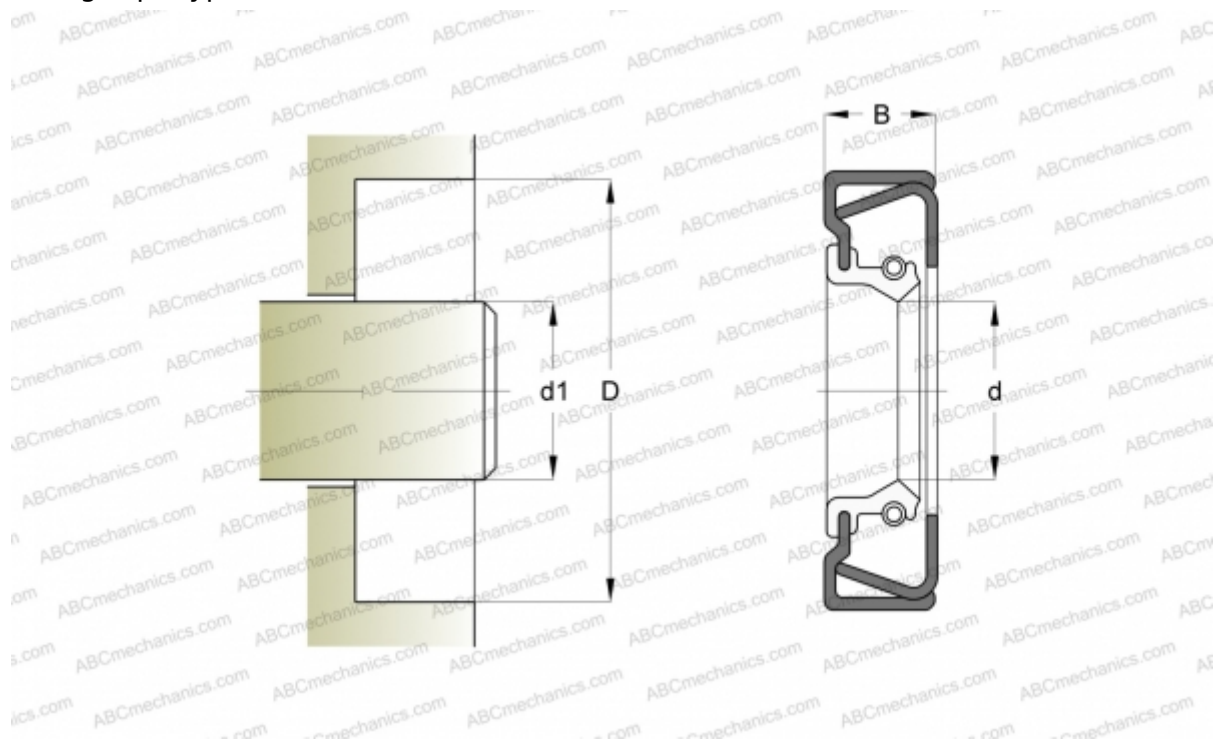

Technical specification

DIMENSIONS, MM

| | |
|----|---------|
| d1 | 96,000 |
| d | 96,000 |
| D | 125,000 |
| B | 13,000 |

MANUFACTURER

[SIMRIT](#)

CALCULATION DATA

| | |
|--|------------|
| Operating temperature min | -40 °C |
| Operating temperature max | 100 °C |
| Permissible operating temperature, short periods max | 120 °C |
| Pressure differential max | 0,050 Mpa |
| Maximum shaft surface speed | 10,000 m/s |

REPLACES

B2U 96-125-13 72 NBR 902 (23265)