

## 9548 SIMRIT

Radial shaft seals

TYPE: Radial shaft seals, Metal case and a secondary reinforcement in the side face, With spring-loaded sealing slip, Type B2, material 72 NBR 902 (SIMRIT)

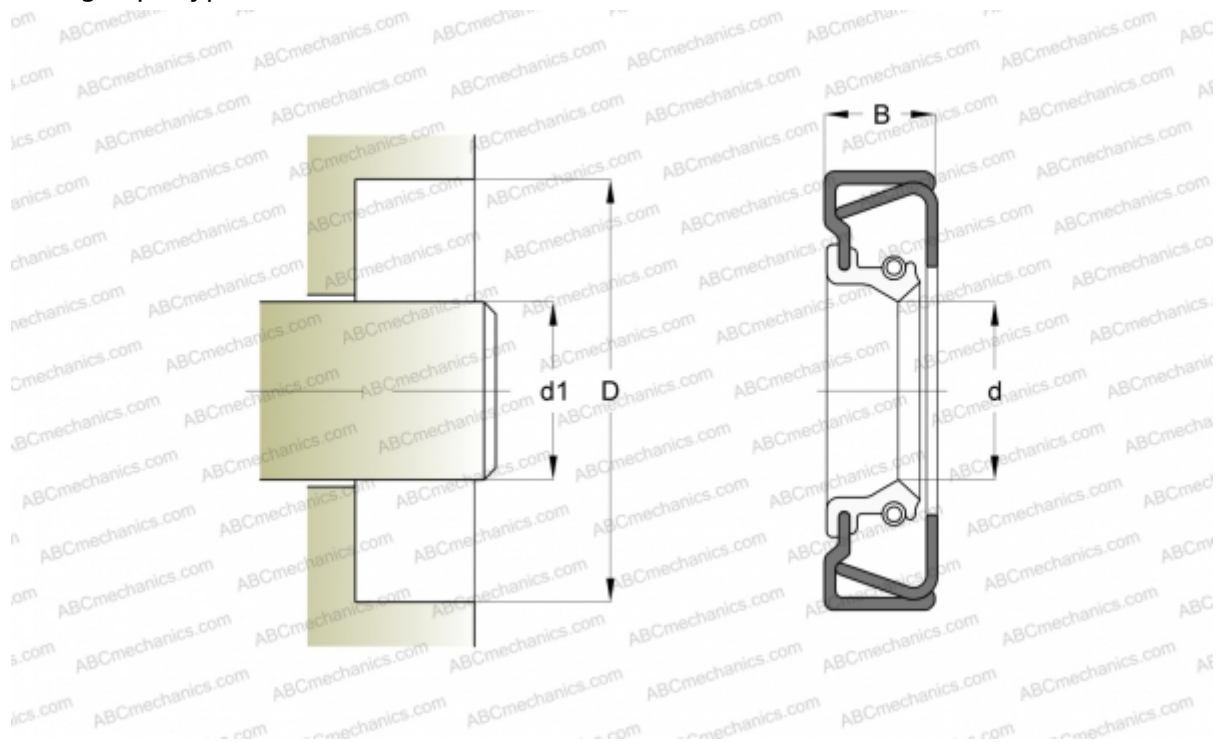

### Technical specification

#### DIMENSIONS, MM

d1	40,000
d	40,000
D	72,000
B	9,000

**MANUFACTURER** [SIMRIT](#)

#### CALCULATION DATA

Operating temperature min	-40 °C
Operating temperature max	100 °C
Permissible operating temperature, short periods max	120 °C
Pressure differential max	0,050 Mpa
Maximum shaft surface speed	10,000 m/s

#### REPLACES

B2 40-72-9 72 NBR 902 (9548)