

23252 SIMRIT

Radial shaft seals

TYPE: Radial shaft seals, Metal case and a secondary reinforcement in the side face, With spring-loaded sealing slip, Type B2, material 72 NBR 902 (SIMRIT)

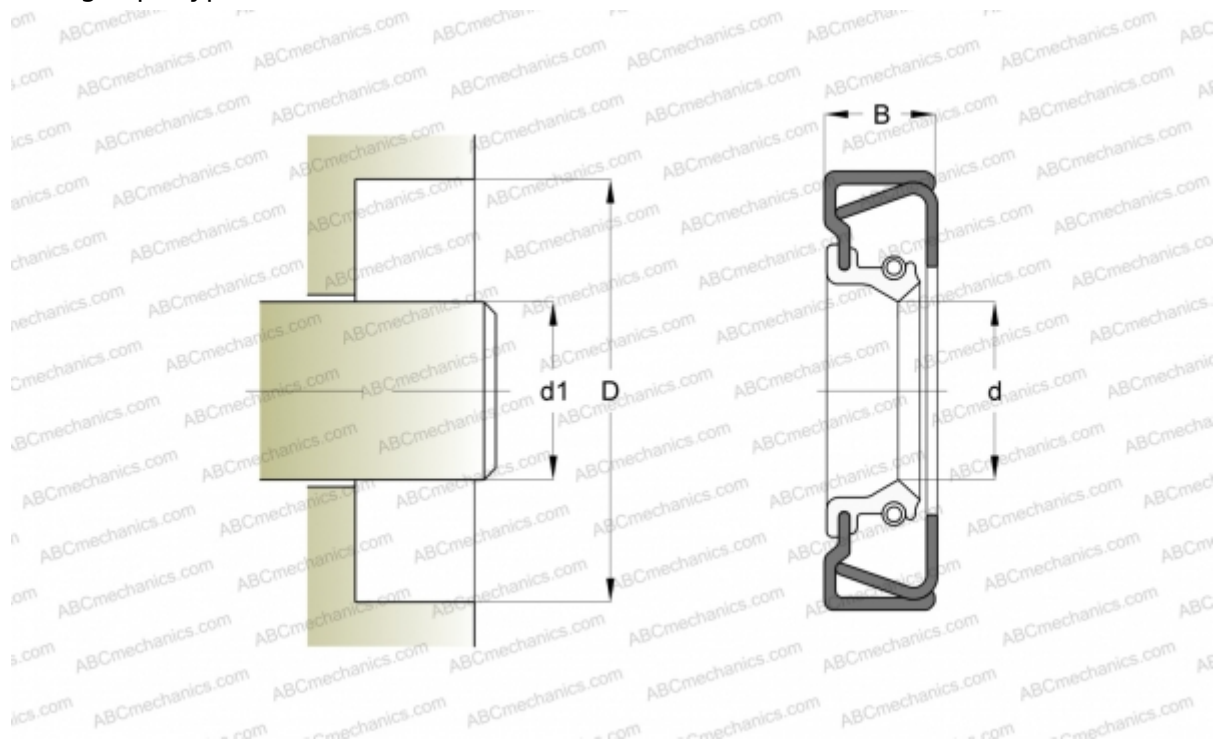

Technical specification

DIMENSIONS, MM

d_1	90,000
d	90,000
D	140,000
B	13,000

MANUFACTURER [SIMRIT](#)

CALCULATION DATA

Operating temperature min	-40 °C
Operating temperature max	100 °C
Permissible operating temperature, short periods max	120 °C
Pressure differential max	0,050 Mpa
Maximum shaft surface speed	10,000 m/s

REPLACES

B2 90-140-13 72 NBR 902 (23252)