

## 2551 SIMRIT

Radial shaft seals

TYPE: Radial shaft seals, Metal case and a secondary reinforcement in the side face, With spring-loaded sealing slip, Type B2, material 72 NBR 902 (SIMRIT)

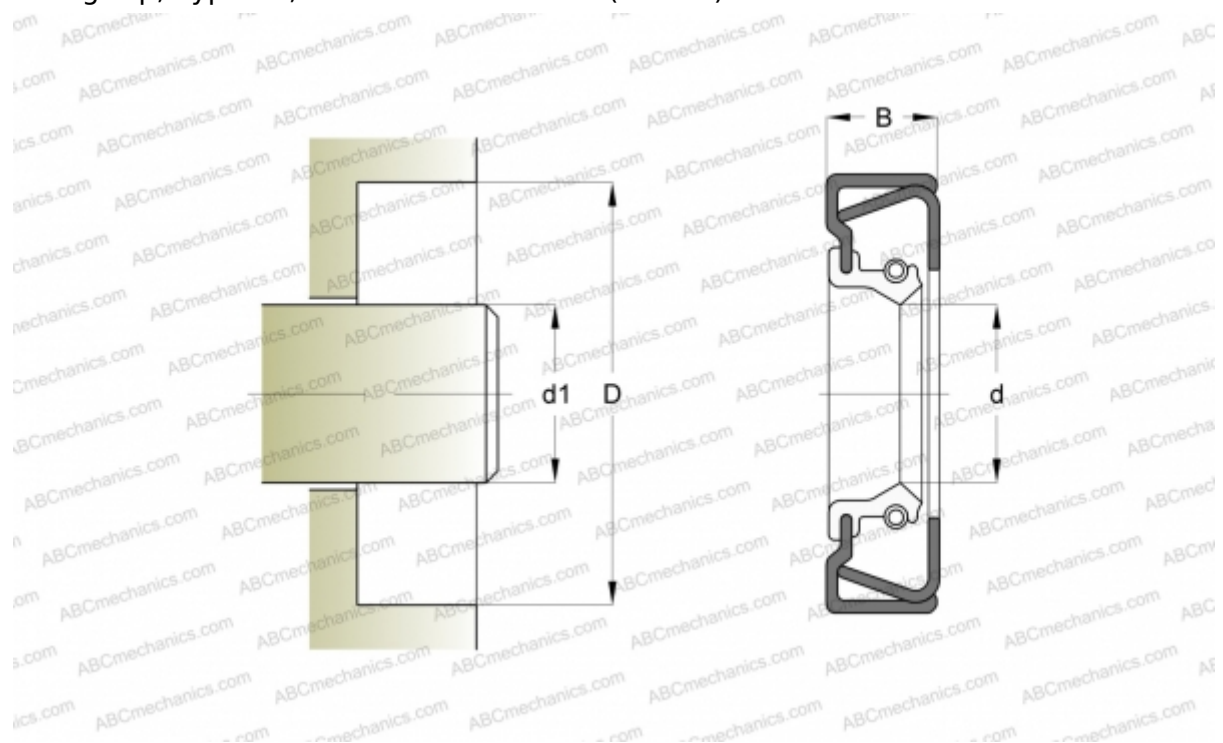

### Technical specification

#### DIMENSIONS, MM

d1	210,000
d	210,000
D	240,000
B	15,000

#### MANUFACTURER

[SIMRIT](#)

#### CALCULATION DATA

Operating temperature min	-40 °C
Operating temperature max	100 °C
Permissible operating temperature, short periods max	120 °C
Pressure differential max	0,050 Mpa
Maximum shaft surface speed	10,000 m/s

#### REPLACES

B2 210-240-15 72 NBR 902 (2551)