

23427 SIMRIT

Radial shaft seals

TYPE: Radial shaft seals, Metal case and a secondary reinforcement in the side face, With spring-loaded sealing slip, Type B2USL, material 72 NBR 902 (SIMRIT)

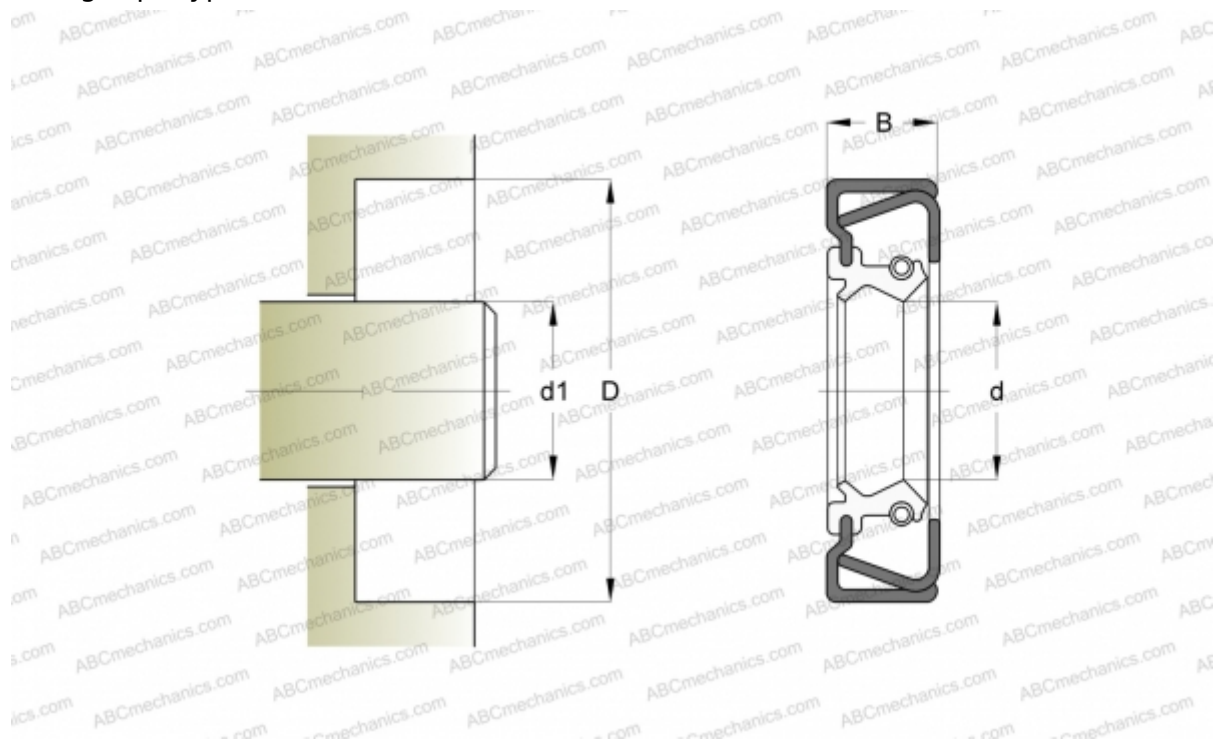

Technical specification

DIMENSIONS, MM

d_1	45,000
d	45,000
D	60,000
B	8,000

MANUFACTURER

[SIMRIT](#)

CALCULATION DATA

Operating temperature min	-40 °C
Operating temperature max	100 °C
Permissible operating temperature, short periods max	120 °C
Pressure differential max	0,050 Mpa
Maximum shaft surface speed	10,000 m/s

REPLACES

B2USL 45-60-8 72 NBR 902 (23427)