

## 409243 SIMRIT

Radial shaft seals

TYPE: Radial shaft seals, Metal case and a secondary reinforcement in the side face, With spring-loaded sealing slip, Type B2USL, material 72 NBR 902 (SIMRIT)

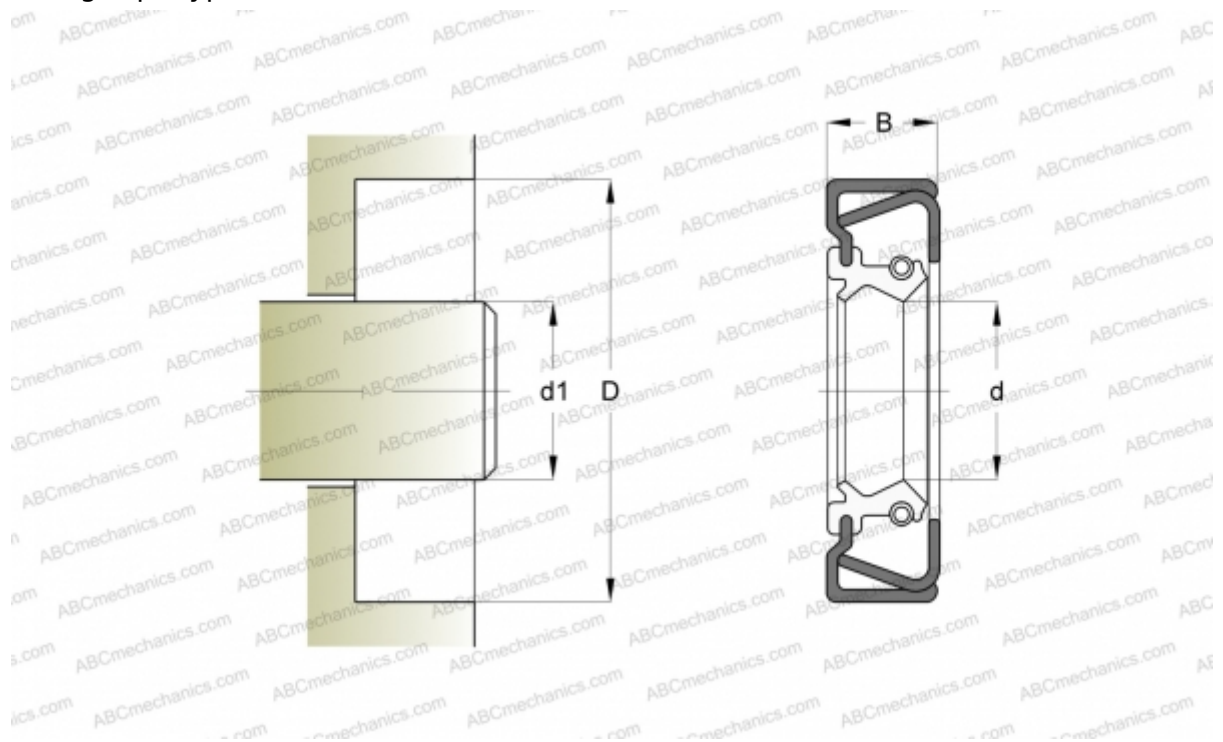

### Technical specification

#### DIMENSIONS, MM

$d_1$	125,000
$d$	125,000
$D$	150,000
$B$	15,000

**MANUFACTURER** [SIMRIT](#)

#### CALCULATION DATA

Operating temperature min	-40 °C
Operating temperature max	100 °C
Permissible operating temperature, short periods max	120 °C
Pressure differential max	0,050 Mpa
Maximum shaft surface speed	10,000 m/s

#### REPLACES

B2USL 125-150-15 72 NBR 902 (409243)