

520466 SIMRIT

Radial shaft seals

TYPE: Radial shaft seals, With a rubber outside diameter, With spring-loaded sealing lip, Type BAUSLX2, material 72 NBR 902 (SIMRIT)

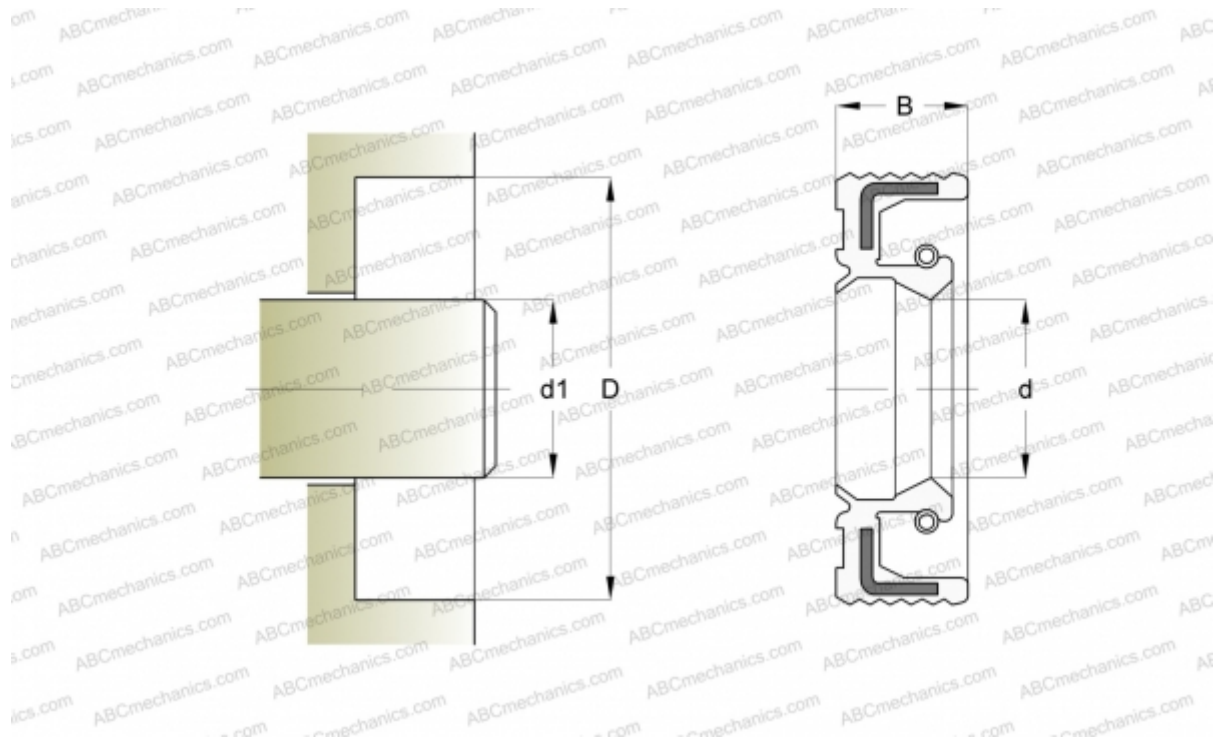

Technical specification

DIMENSIONS, MM

d_1	34,000
d	34,000
D	52,000
B	7,000

MANUFACTURER

[SIMRIT](#)

CALCULATION DATA

Operating temperature min	-40 °C
Operating temperature max	100 °C
Permissible operating temperature, short periods max	120 °C
Pressure differential max	0,050 Mpa
Maximum shaft surface speed	10,000 m/s

REPLACES

BAUSLX2 34-52-7 72 NBR 902 (520466)