

8927 SIMRIT

Radial shaft seals

TYPE: Radial shaft seals, With a rubber outside diameter, With spring-loaded sealing lip, Type BASL, material 72 NBR 902 (SIMRIT)

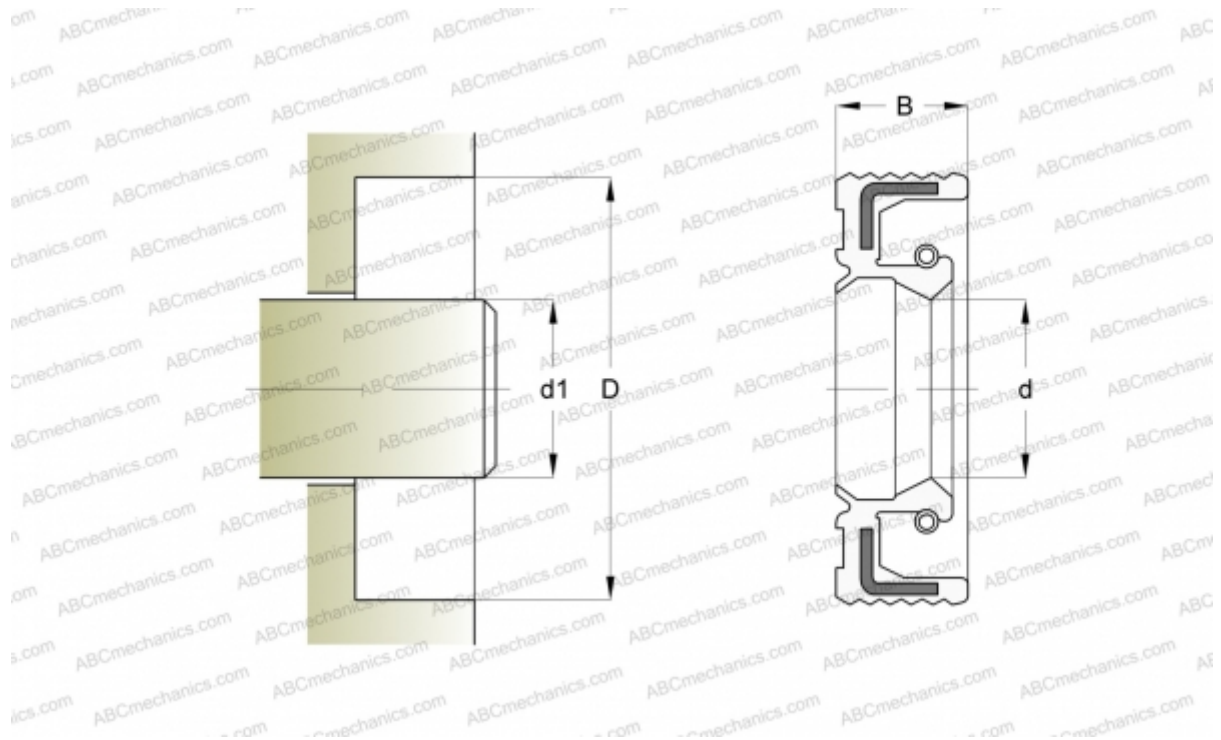

Technical specification

DIMENSIONS, MM

d1	60,000
d	60,000
D	80,000
B	10,000

MANUFACTURER [SIMRIT](#)

CALCULATION DATA

Operating temperature min	-40 °C
Operating temperature max	100 °C
Permissible operating temperature, short periods max	120 °C
Pressure differential max	0,050 Mpa
Maximum shaft surface speed	10,000 m/s

REPLACES

BASL 60-80-10 72 NBR 902 (8927)