

407128 SIMRIT

Radial shaft seals

TYPE: Radial shaft seals, With a rubber outside diameter, With spring-loaded sealing lip, Type BAUMSLX7, material 75 FKM 585 (SIMRIT)

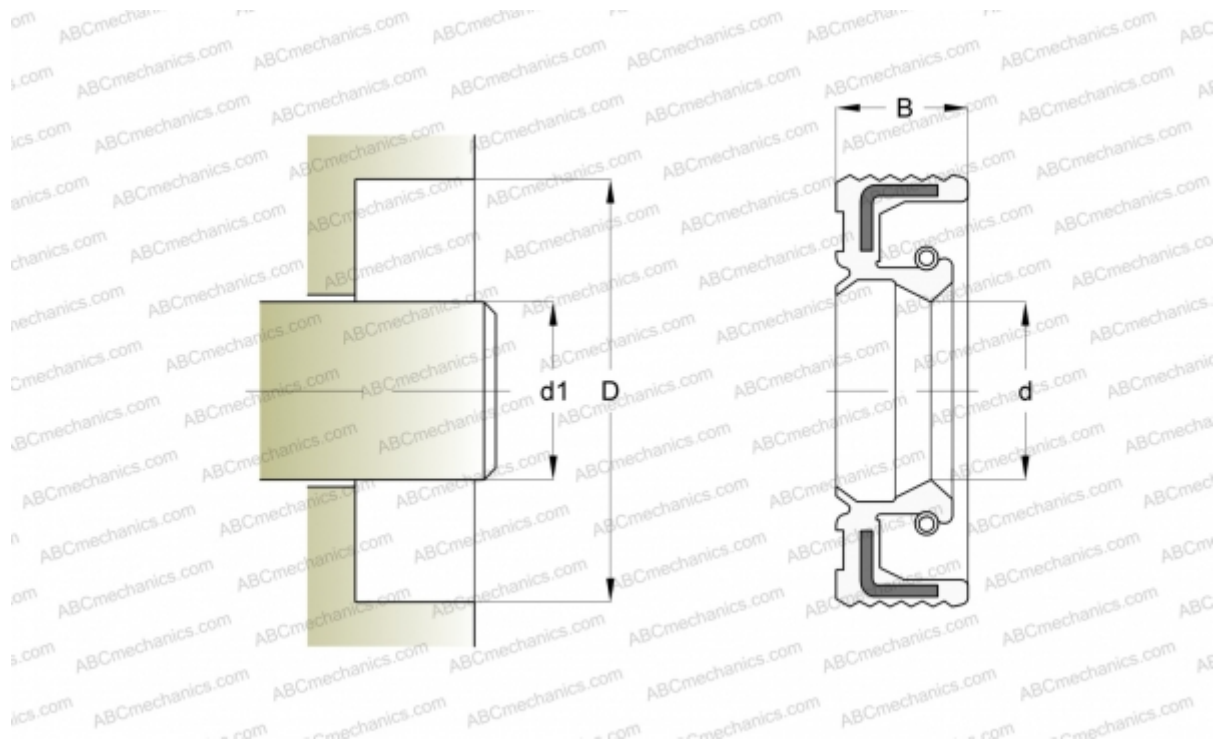

Technical specification

DIMENSIONS, MM

d_1	26,000
d	26,000
D	37,000
B	7,000

MANUFACTURER [SIMRIT](#)

CALCULATION DATA

Operating temperature min	-25 °C
Operating temperature max	160 °C
Pressure differential max	0,050 Mpa
Maximum shaft surface speed	30,000 m/s

REPLACES

BAUMSLX7 26-37-7 75 FKM 585 (407128)