

410408 SIMRIT

Radial shaft seals

TYPE: Radial shaft seals, With a rubber outside diameter, With spring-loaded sealing lip, Type BAUMSLX7, material 75 FKM 585 (SIMRIT)

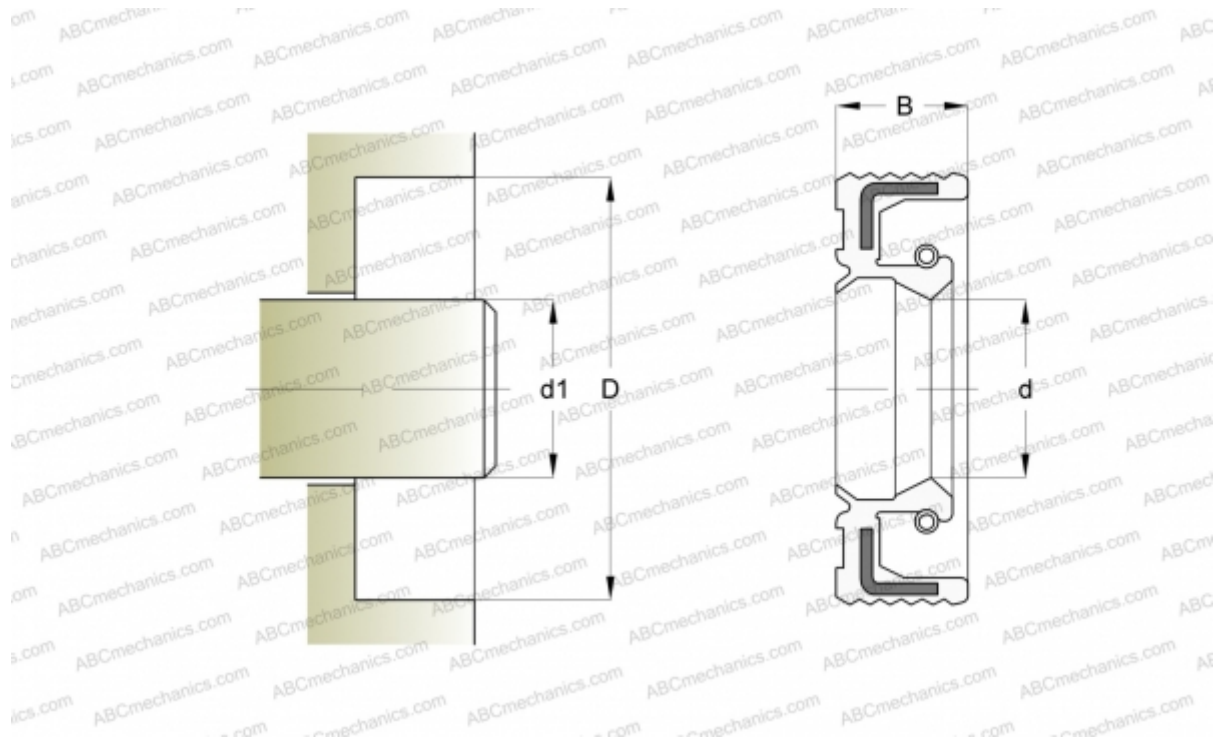

Technical specification

DIMENSIONS, MM

d_1	65,000
d	65,000
D	100,000
B	10,000

MANUFACTURER

[SIMRIT](#)

CALCULATION DATA

Operating temperature min	-25 °C
Operating temperature max	160 °C
Pressure differential max	0,050 Mpa
Maximum shaft surface speed	30,000 m/s

REPLACES

BAUMSLX7 65-100-10 75 FKM 585 (410408)