

68078 SIMRIT

Radial shaft seals

TYPE: Radial shaft seals, With a rubber outside diameter, With spring-loaded sealing lip, Type BABSL, material 72 NBR 902 (SIMRIT)

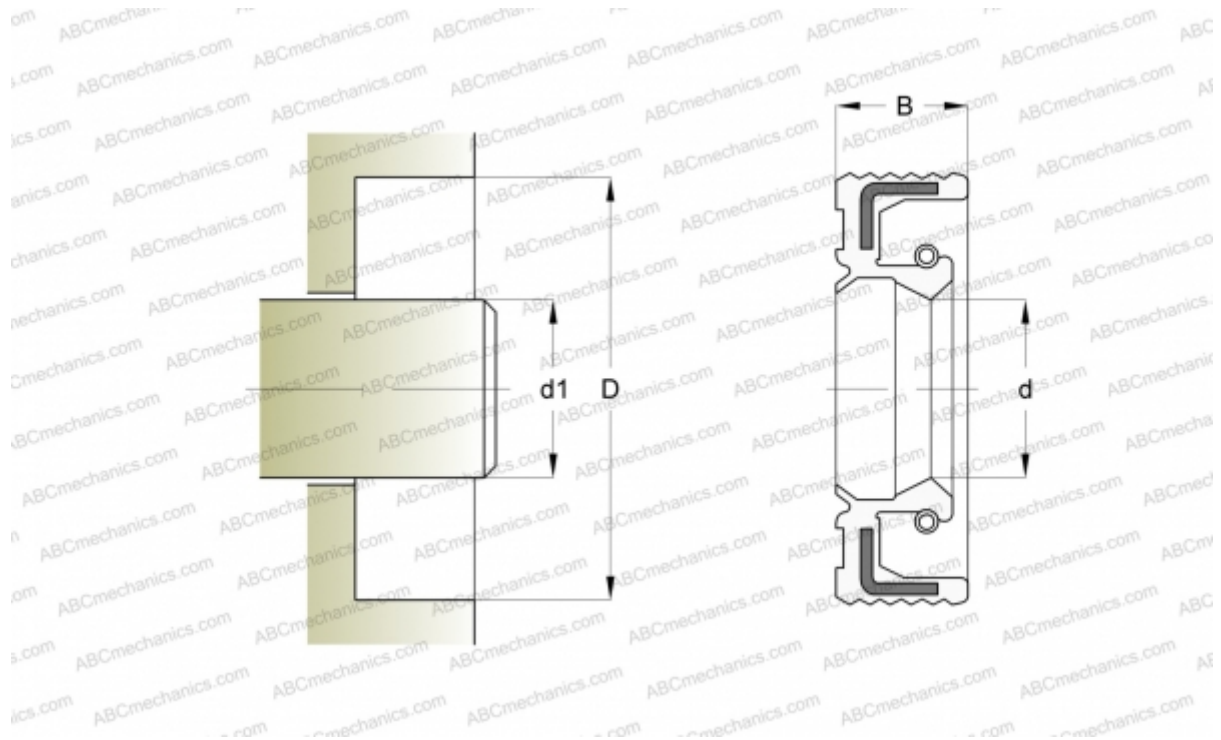

Technical specification

DIMENSIONS, MM

d1	28,000
d	28,000
D	40,000
B	9,000

MANUFACTURER [SIMRIT](#)

CALCULATION DATA

Operating temperature min	-40 °C
Operating temperature max	100 °C
Maximum shaft surface speed	10,000 m/s

REPLACES

BABSL 28-40-9 72 NBR 902 (68078)