

12011530 SIMRIT

Radial shaft seals

TYPE: Radial shaft seals, With a rubber outside diameter, With spring-loaded sealing lip, Type BABSL, material 72 NBR 902 (SIMRIT)

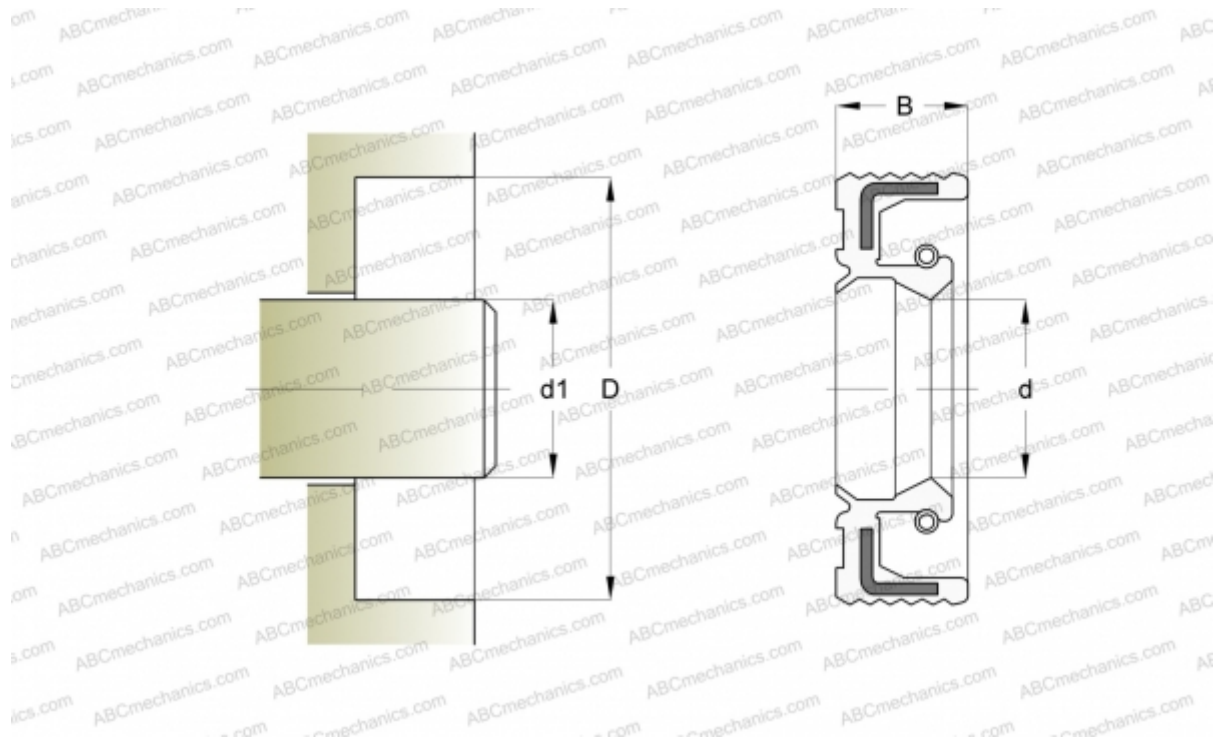

Technical specification

DIMENSIONS, MM

d_1	55,000
d	55,000
D	72,000
B	8,000

MANUFACTURER [SIMRIT](#)

CALCULATION DATA

Operating temperature min	-40 °C
Operating temperature max	100 °C
Maximum shaft surface speed	10,000 m/s

REPLACES

BABSL 55-72-8 72 NBR 902 (12011530)