

418629 SIMRIT

Radial shaft seals

TYPE: Radial shaft seals, With a rubber outside diameter, With spring-loaded sealing lip, Type BABSL, material 75 FKM 585 (SIMRIT)

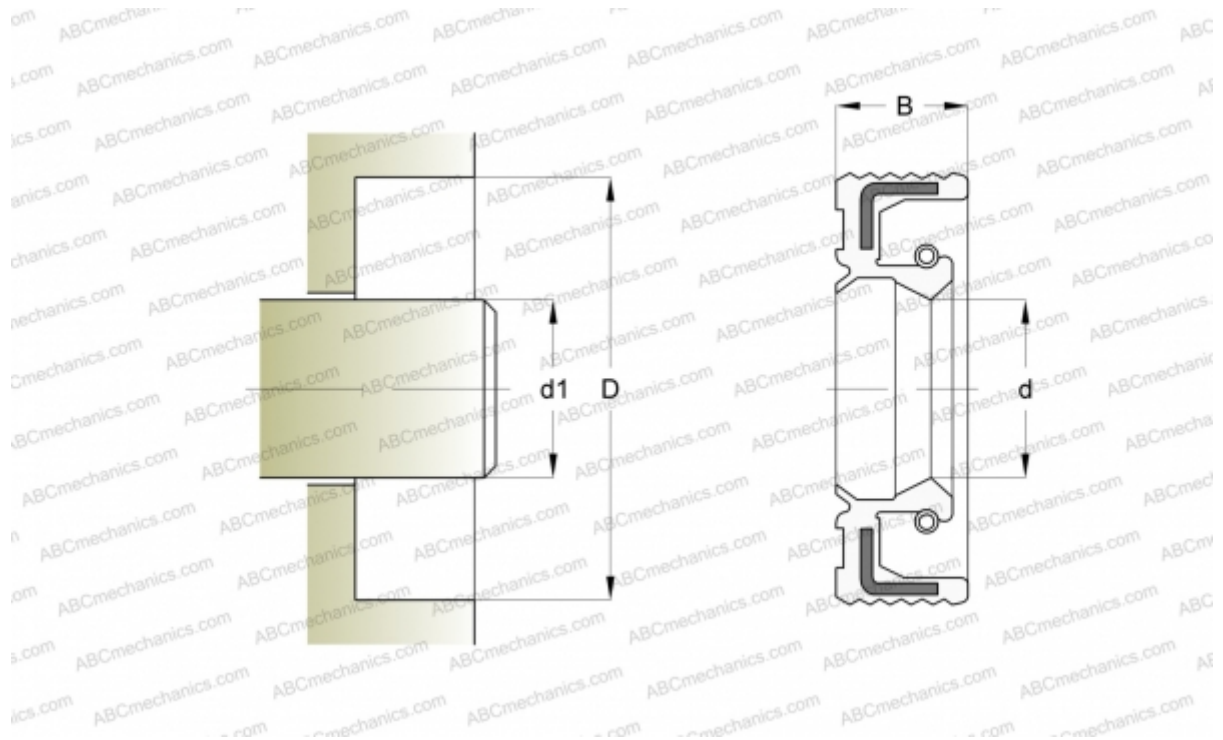

Technical specification

DIMENSIONS, MM

d1	30,000
d	30,000
D	42,000
B	6,000

MANUFACTURER [SIMRIT](#)

CALCULATION DATA

Operating temperature min	-25 °C
Operating temperature max	160 °C
Maximum shaft surface speed	10,000 m/s

REPLACES

BABSL 30-42-6 75 FKM 595 (418629)