

## 360204 SIMRIT

Radial shaft seals

TYPE: Radial shaft seals, With a rubber outside diameter, With spring-loaded sealing lip, Type BABSL, material 75 FKM 585 (SIMRIT)

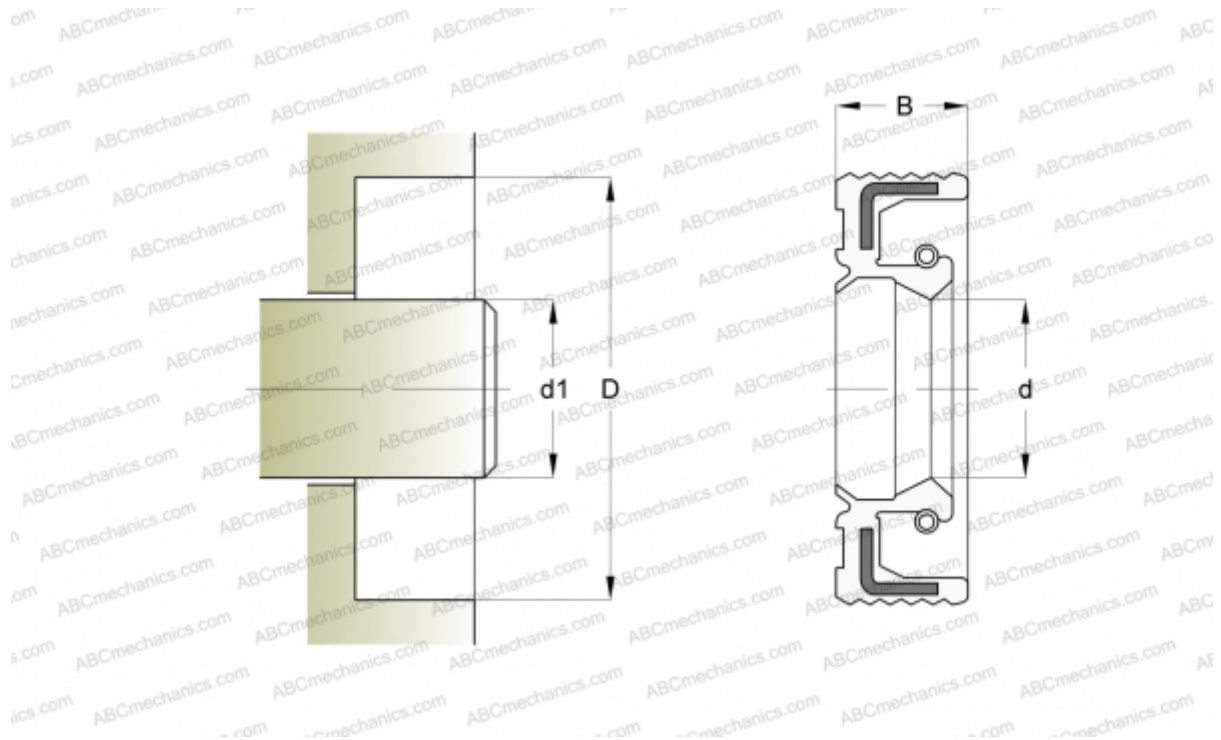

### Technical specification

#### DIMENSIONS, MM

d1	50,000
d	50,000
D	68,000
B	7,000

**MANUFACTURER** [SIMRIT](#)

#### CALCULATION DATA

Operating temperature min	-25 °C
Operating temperature max	160 °C
Maximum shaft surface speed	10,000 m/s

#### REPLACES

BABSL 50-68-7 75 FKM 595 (360204)