

525407 SIMRIT

Radial shaft seals

TYPE: Radial shaft seals, Special designs, Type MSS-1, material 72 NBR 902 (SIMRIT)

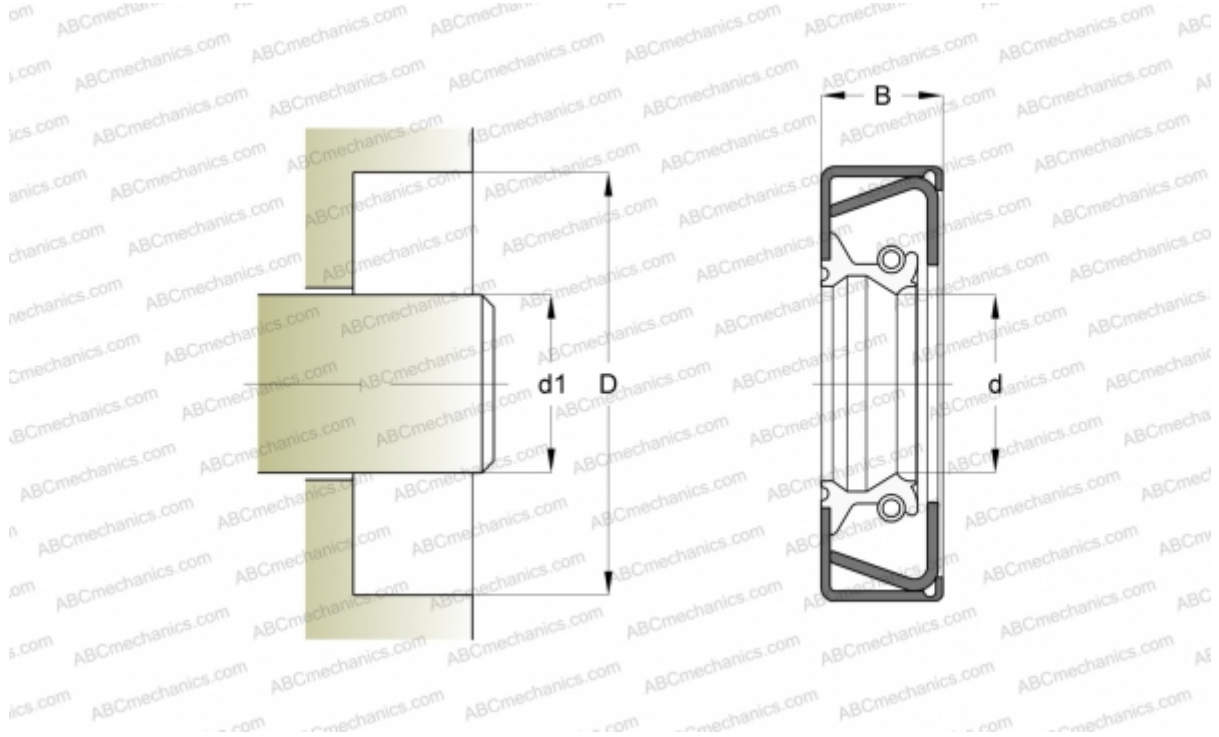

Technical specification

DIMENSIONS, MM

d_1	82,000
d	82,000
D	160,000
B	13,000

MANUFACTURER [SIMRIT](#)

CALCULATION DATA

Operating temperature min	-25 °C
Operating temperature max	100 °C
Pressure differential max	0,050 Mpa
Maximum shaft surface speed	6,000 m/s

REPLACES

MSS-1 82-160-13 72 NBR 902 (525407)