

525404 SIMRIT

Radial shaft seals

TYPE: Radial shaft seals, Special designs, Type MSS-1, material 72 NBR 902 (SIMRIT)

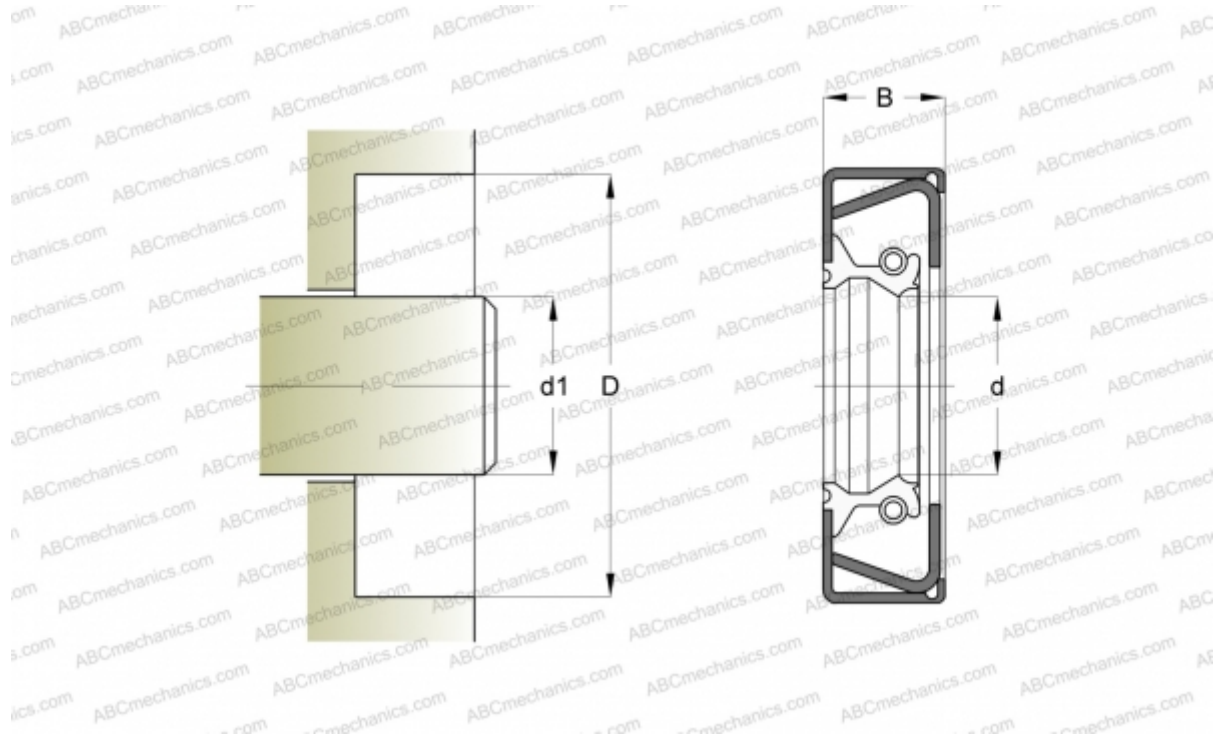

Technical specification

DIMENSIONS, MM

d_1	108,000
d	108,000
D	140,000
B	15,000

MANUFACTURER [SIMRIT](#)

CALCULATION DATA

Operating temperature min	-25 °C
Operating temperature max	100 °C
Pressure differential max	0,050 Mpa
Maximum shaft surface speed	6,000 m/s

REPLACES

MSS-1 108-140-15 72 NBR 902 (525404)