

## 525381 SIMRIT

Radial shaft seals

TYPE: Radial shaft seals, Special designs, Type MSS-1, material 75 FKM 585 (SIMRIT)

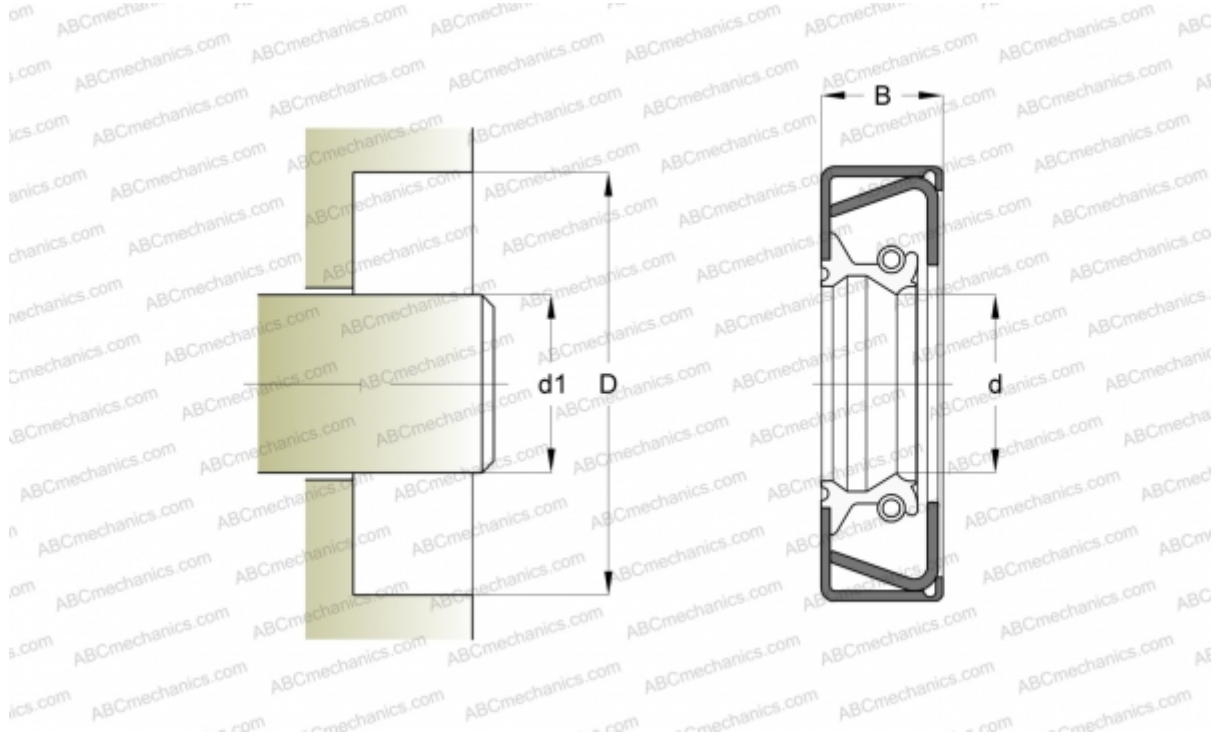

### Technical specification

#### DIMENSIONS, MM

$d_1$	75,000
$d$	75,000
$D$	130,000
$B$	12,000

**MANUFACTURER** [SIMRIT](#)

#### CALCULATION DATA

Operating temperature min	-25 °C
Operating temperature max	160 °C
Pressure differential max	0,050 Mpa
Maximum shaft surface speed	6,000 m/s

#### REPLACES

MSS-1 75-130-12 75 FKM 585 (525381)