

525391 SIMRIT

Radial shaft seals

TYPE: Radial shaft seals, Special designs, Type MSS-1, material 75 FKM 585 (SIMRIT)

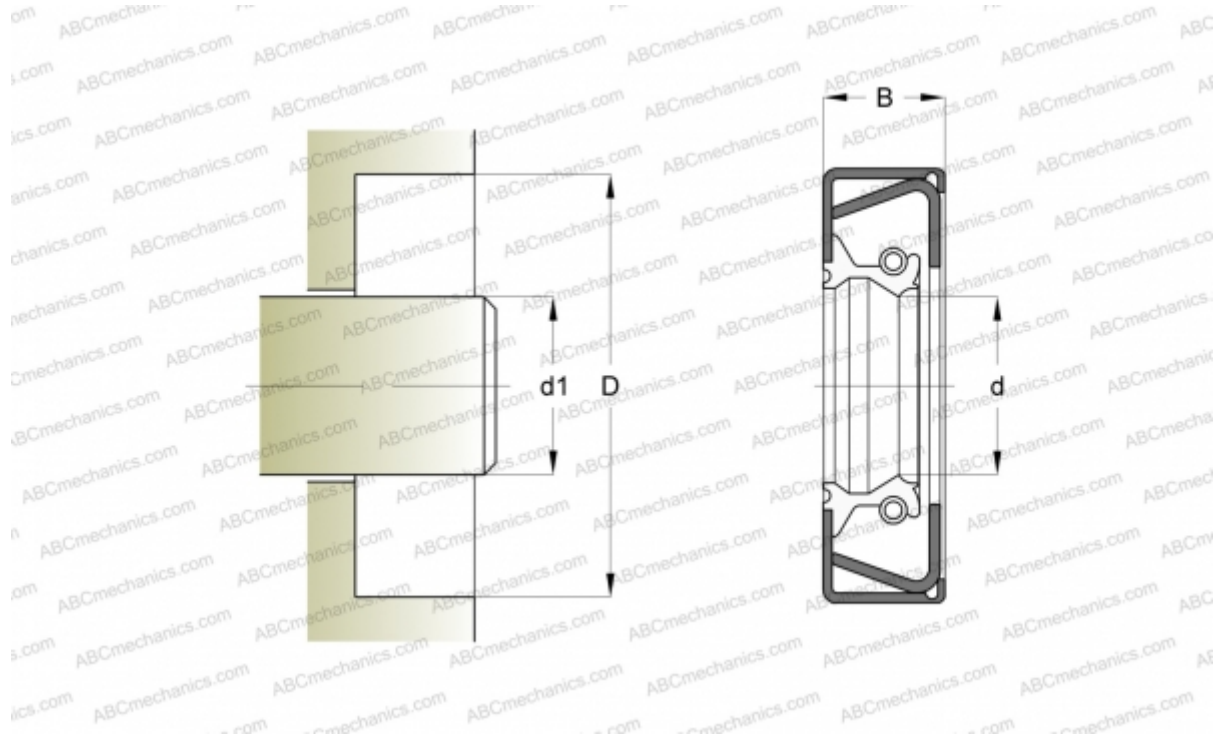

Technical specification

DIMENSIONS, MM

d1	85,000
d	85,000
D	110,000
B	12,000

MANUFACTURER [SIMRIT](#)

CALCULATION DATA

Operating temperature min	-25 °C
Operating temperature max	160 °C
Pressure differential max	0,050 Mpa
Maximum shaft surface speed	6,000 m/s

REPLACES

MSS-1 85-110-12 75 FKM 585 (525391)