

PHS 100-1B13 SKF

ANSI sprockets

TYPE: Simplex, Pilot bore, hub on one side, Standard ANSI (SKF)

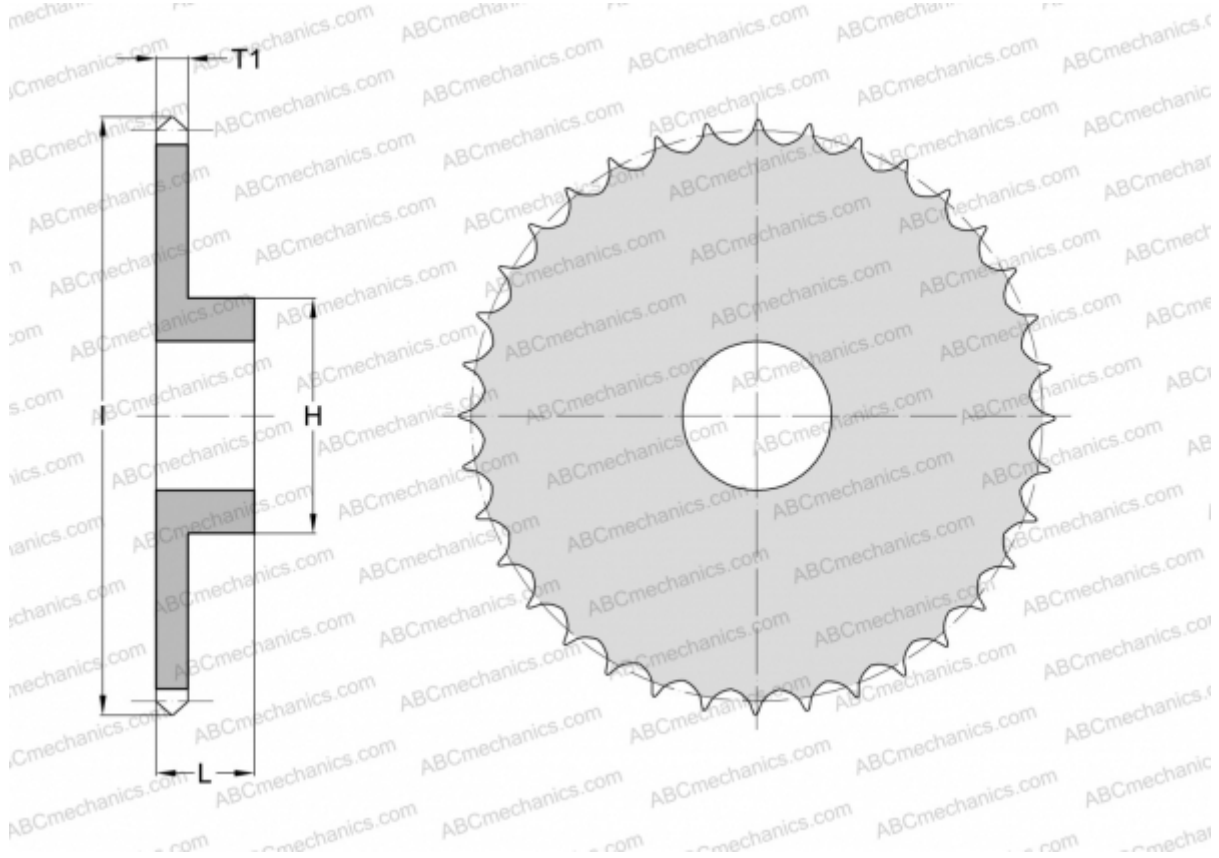

Technical specification

DIMENSIONS, MM

Pitch, p	31,750
Dimensions bore, min	25,400
Dimensions bore, max	60,325
Hub, H	98,425
Thickness, T1	17,570
l	147,828
Number of teeth	13

WEIGHT, KG 2,970

MANUFACTURER [SKF](#)