

PHS 100-1B14 SKF

ANSI sprockets

TYPE: Simplex, Pilot bore, hub on one side, Standard ANSI (SKF)

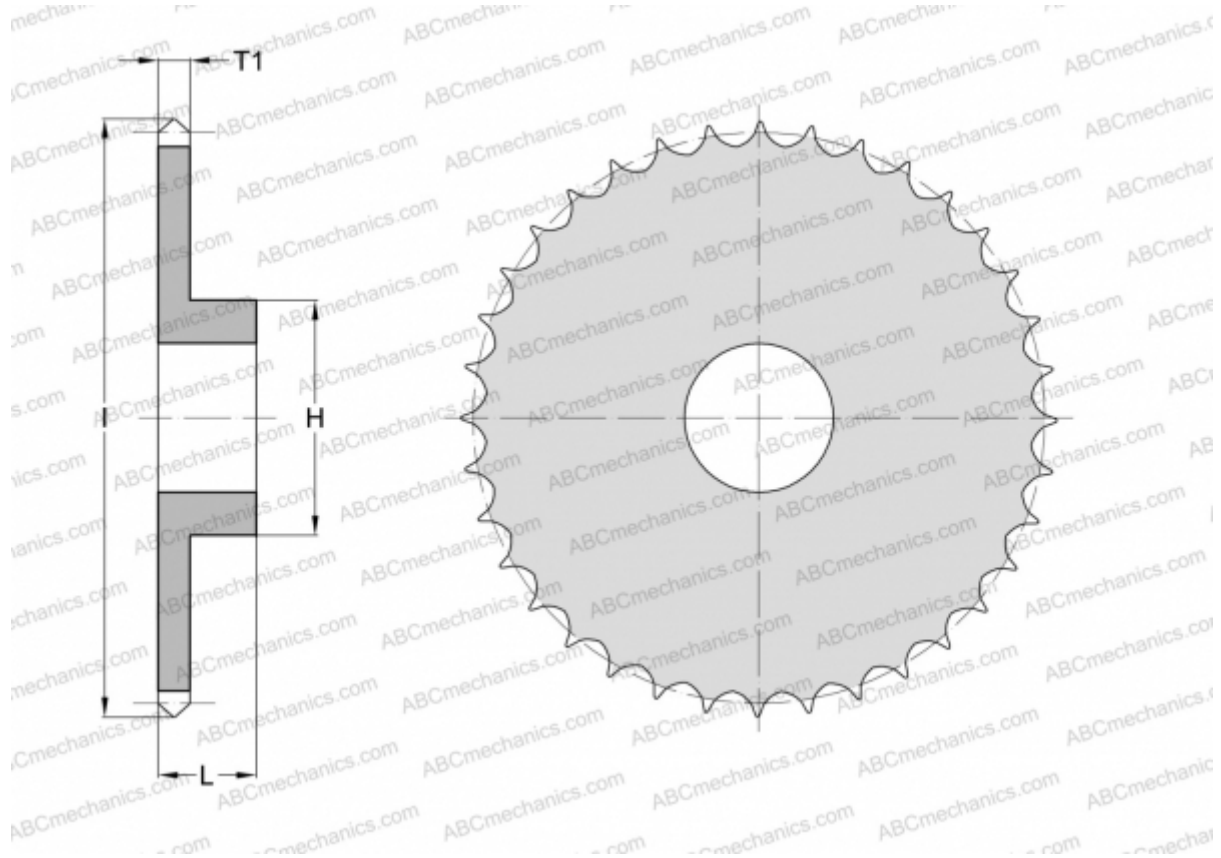

Technical specification

DIMENSIONS, MM

Pitch, p	31,750
Dimensions bore, min	31,750
Dimensions bore, max	69,850
Hub, H	106,360
Thickness, T1	17,570
L	158,242
Number of teeth	14

WEIGHT, KG 3,330

MANUFACTURER [SKF](#)