

PHS 100-1B16 SKF

ANSI sprockets

TYPE: Simplex, Pilot bore, hub on one side, Standard ANSI (SKF)

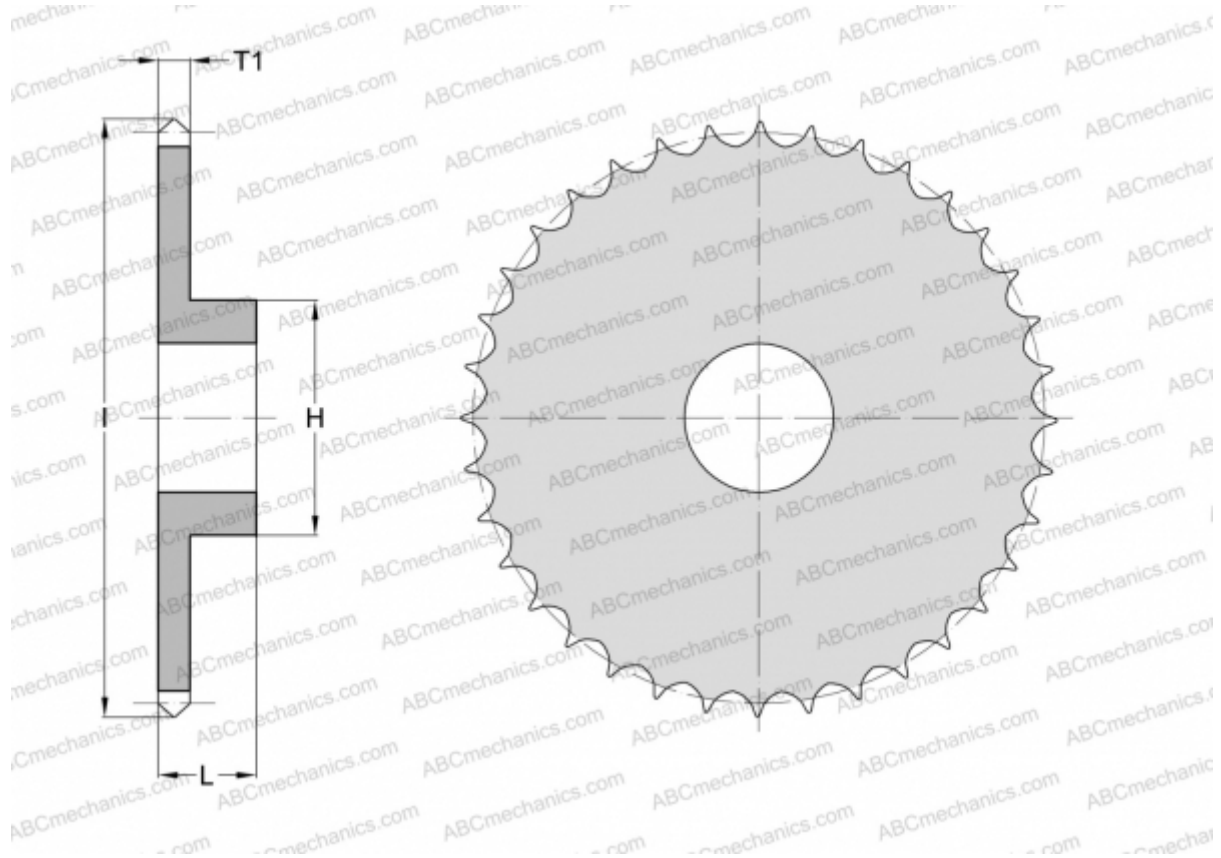

Technical specification

DIMENSIONS, MM

Pitch, p	31,750
Dimensions bore, min	33,337
Dimensions bore, max	76,200
Hub, H	114,300
Thickness, T1	17,570
L	178,562
Number of teeth	16

WEIGHT, KG 4,455

MANUFACTURER [SKF](#)