

PHS 100-1B18 SKF

ANSI sprockets

TYPE: Simplex, Pilot bore, hub on one side, Standard ANSI (SKF)

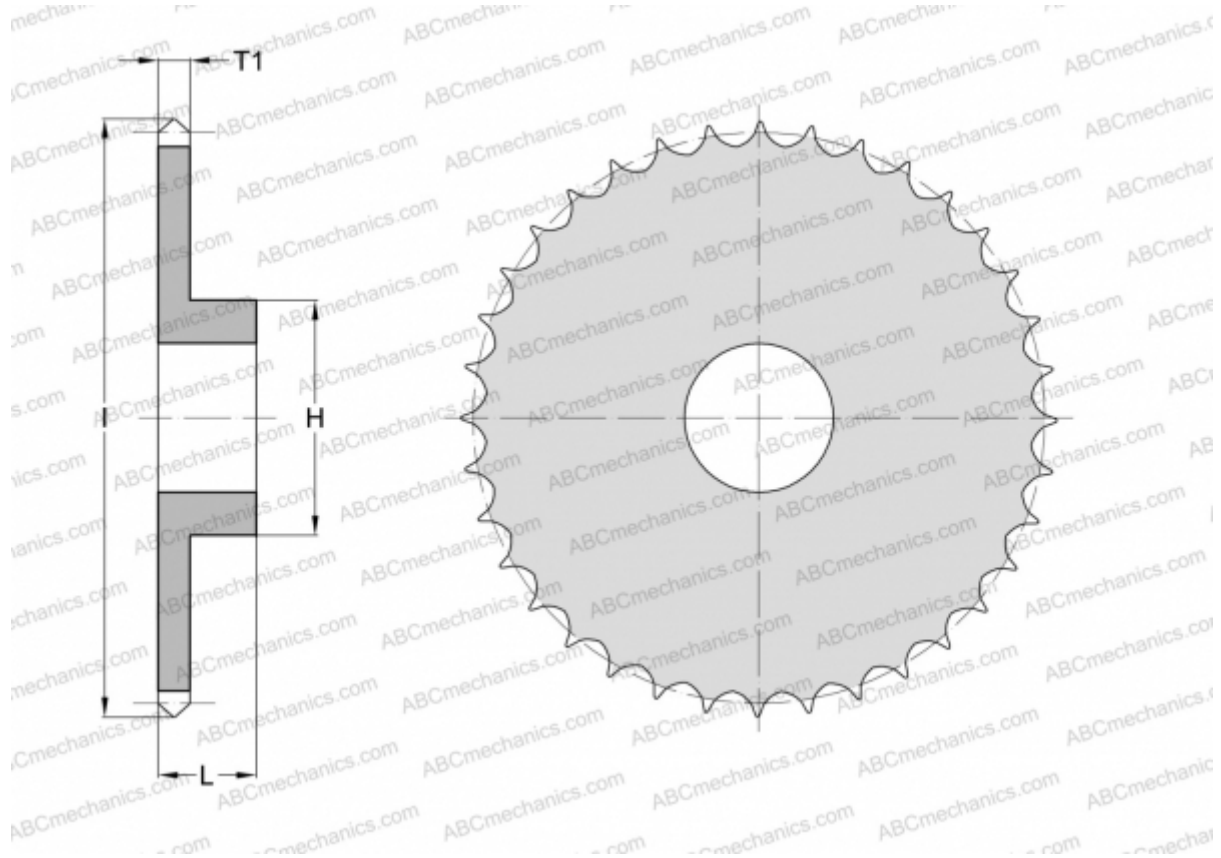

Technical specification

DIMENSIONS, MM

Pitch, p	31,750
Dimensions bore, min	33,337
Dimensions bore, max	76,200
Hub, H	114,300
Thickness, T1	17,570
L	199,136
Number of teeth	18

WEIGHT, KG 5,175

MANUFACTURER [SKF](#)