

PHS 16B-1C70 SKF

Metric sprockets

TYPE: Simplex, Pilot bore, hub on two side, Standard BS/ISO (SKF)

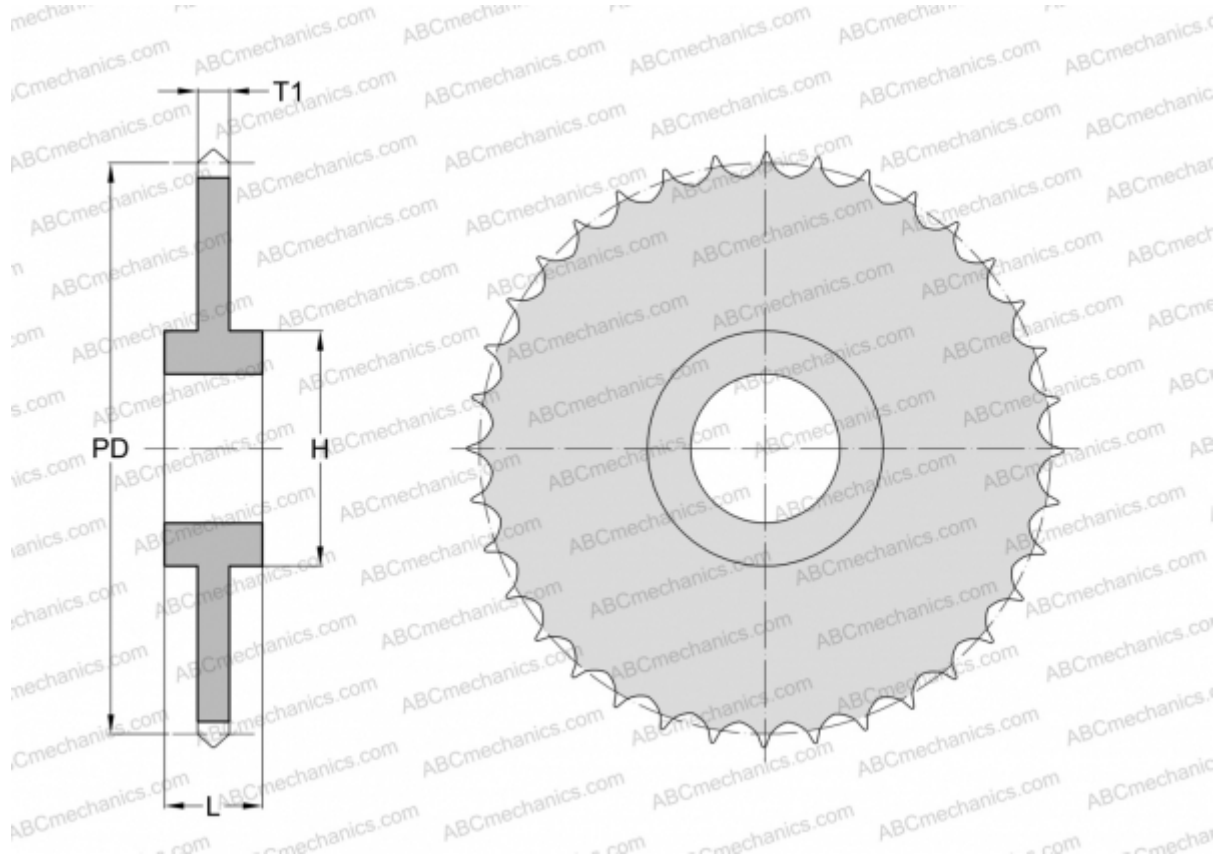

Technical specification

DIMENSIONS, MM

Pitch, p	25,400
Pitch diameter, PD	566,140
Dimensions bore, min	25,000
Dimensions bore, max	108,000
Hub, H	140,000
Thickness, T1	16,180
Number of teeth	70

WEIGHT, KG 29,060

MANUFACTURER [SKF](#)