

## PHS 16B-1C76 SKF

Metric sprockets

TYPE: Simplex, Pilot bore, hub on two side, Standard BS/ISO (SKF)

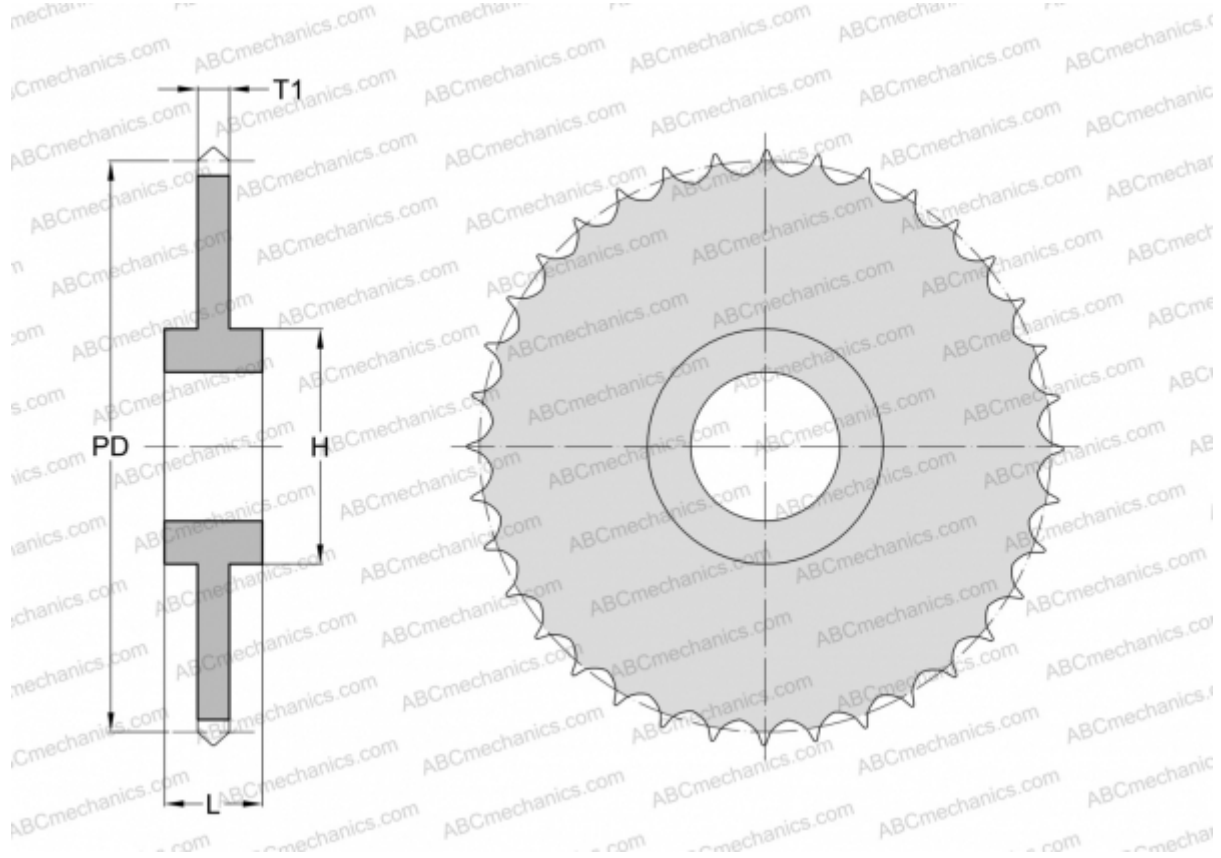

### Technical specification

#### DIMENSIONS, MM

Pitch, p	25,400
Pitch diameter, PD	614,650
Dimensions bore, min	25,000
Dimensions bore, max	75,000
Hub, H	140,000
Thickness, T1	16,180
Number of teeth	76

**WEIGHT, KG** 28,500

**MANUFACTURER** [SKF](#)