

PHS 16B-1C90 SKF

Metric sprockets

TYPE: Simplex, Pilot bore, hub on two side, Standard BS/ISO (SKF)

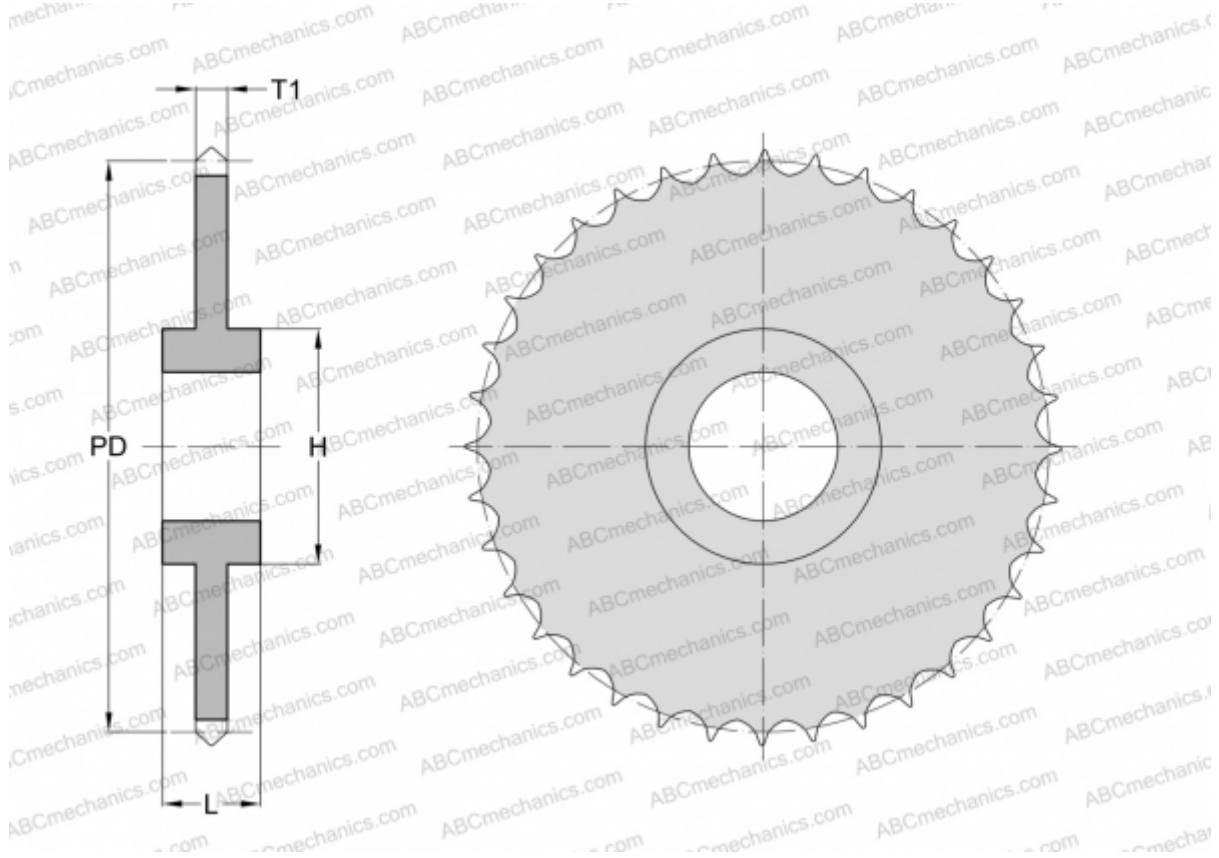

Technical specification

DIMENSIONS, MM

Pitch, p	25,400
Pitch diameter, PD	727,810
Dimensions bore, min	25,000
Dimensions bore, max	108,000
Hub, H	140,000
Thickness, T1	16,180
Number of teeth	90

WEIGHT, KG 39,860

MANUFACTURER [SKF](#)