

PHS 100-1C80 SKF

ANSI sprockets

TYPE: Simplex, Pilot bore, hub on two side, Standard ANSI (SKF)

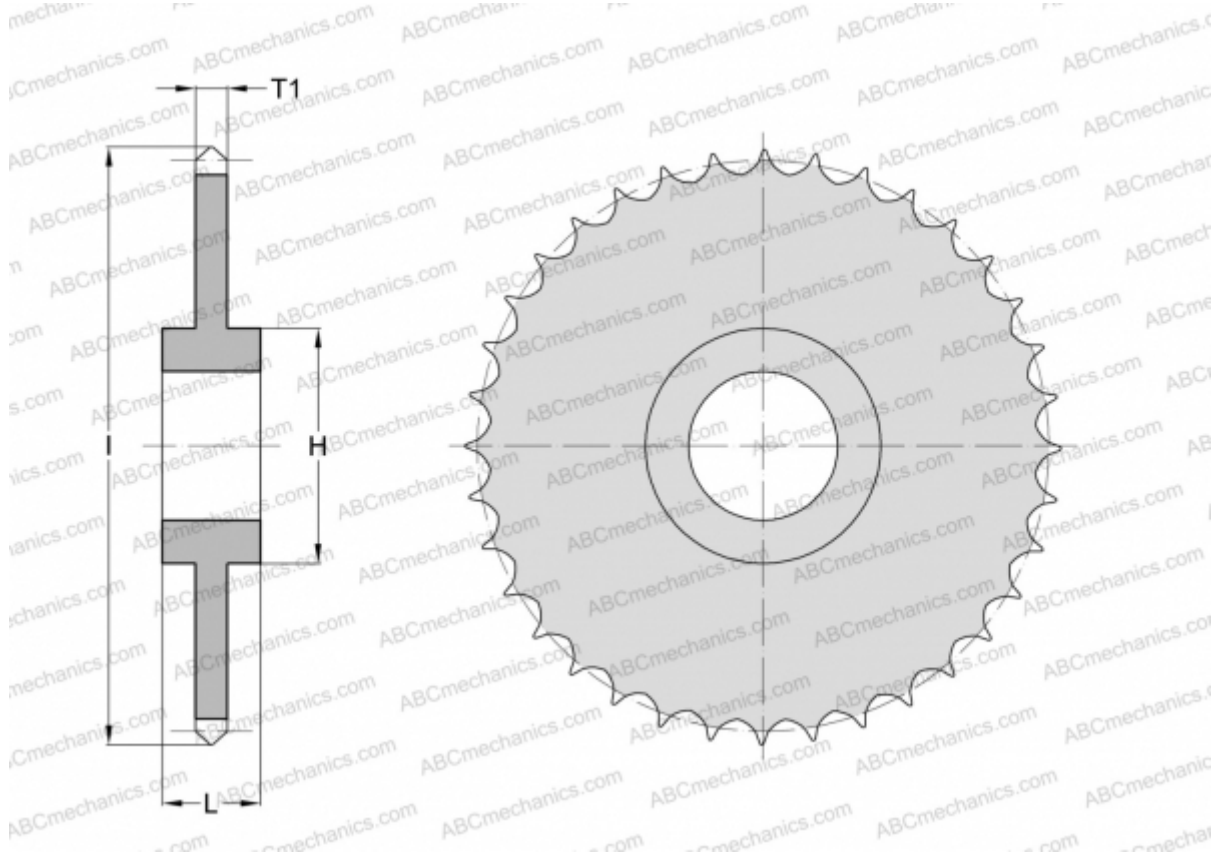

Technical specification

DIMENSIONS, MM

Pitch, p	31,750
Dimensions bore, min	38,100
Dimensions bore, max	133,350
Hub, H	177,800
Thickness, T1	17,570
L	827,278
Number of teeth	80

WEIGHT, KG 67,950

MANUFACTURER [SKF](#)