

## PHS 100-1C90 SKF

ANSI sprockets

TYPE: Simplex, Pilot bore, hub on two side, Standard ANSI (SKF)

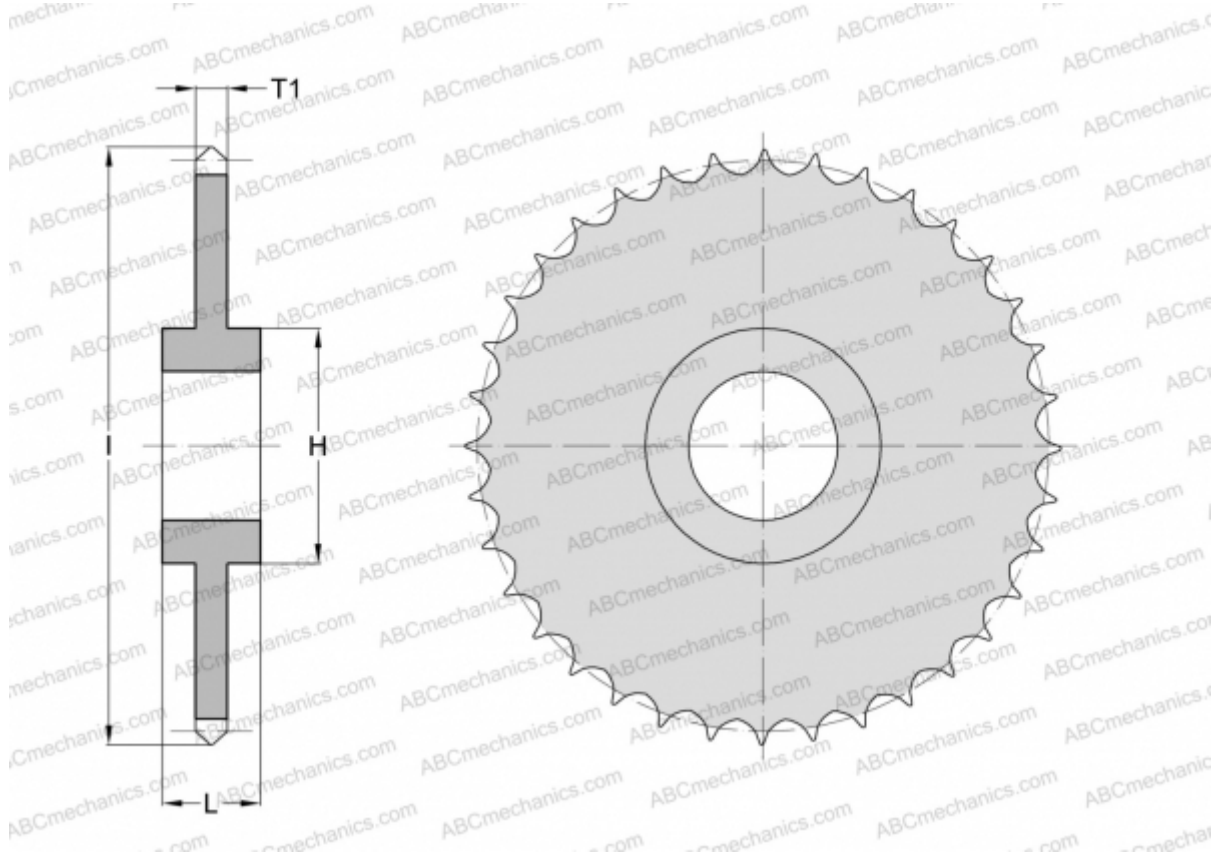

### Technical specification

#### DIMENSIONS, MM

Pitch, p	31,750
Dimensions bore, min	38,100
Dimensions bore, max	133,350
Hub, H	177,800
Thickness, T1	17,570
L	928,370
Number of teeth	90

**WEIGHT, KG** 82,800

**MANUFACTURER** [SKF](#)