

## PHS 120-1C40 SKF

ANSI sprockets

TYPE: Simplex, Pilot bore, hub on two side, Standard ANSI (SKF)

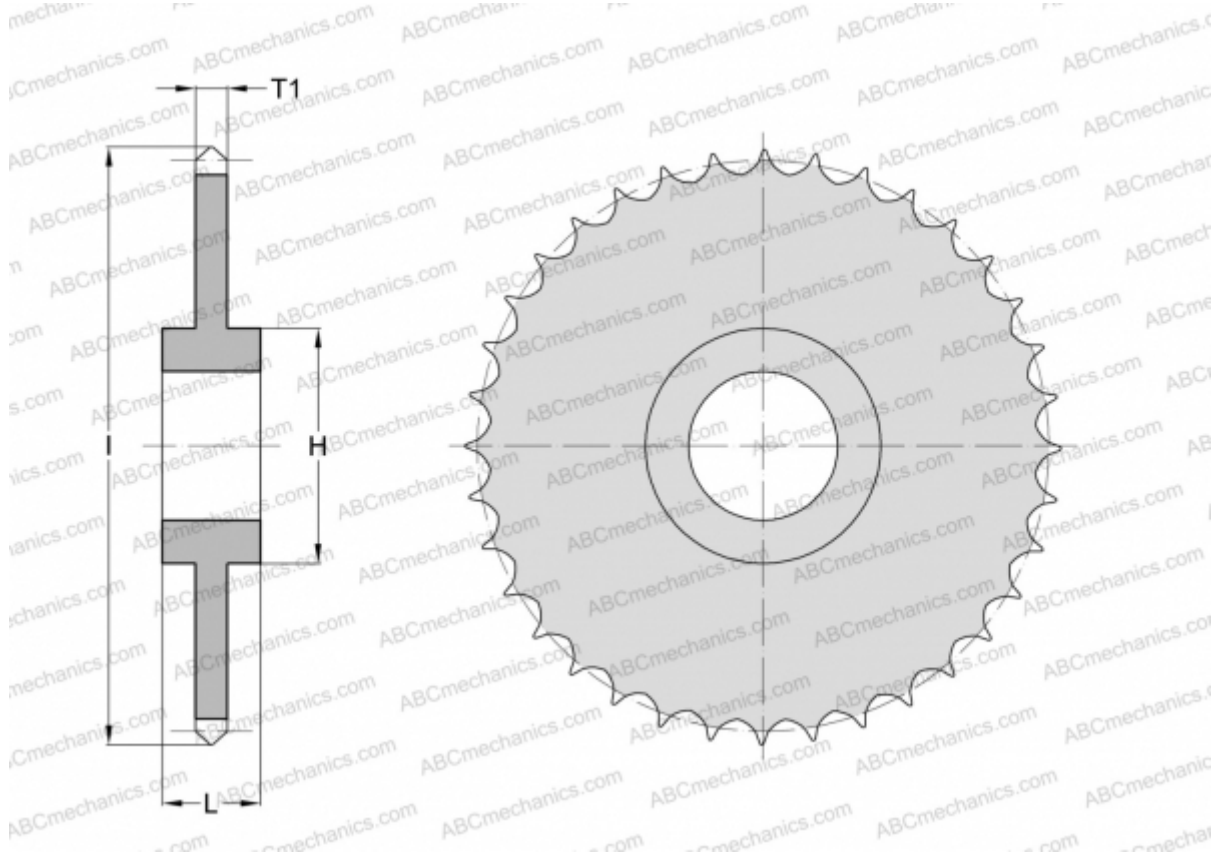

### Technical specification

#### DIMENSIONS, MM

Pitch, p	38,100
Dimensions bore, min	38,100
Dimensions bore, max	101,600
Hub, H	152,400
Thickness, T1	23,470
L	506,984
Number of teeth	40

**WEIGHT, KG** 41,400

**MANUFACTURER** [SKF](#)