

KSR16-LO-06-10-20-08 INA

Roller chain idler sprocket unit

TYPE: Simplex, Roller chain idler sprocket units, Sprocket made from steel or sintered iron, type KSR...-LO (INA)

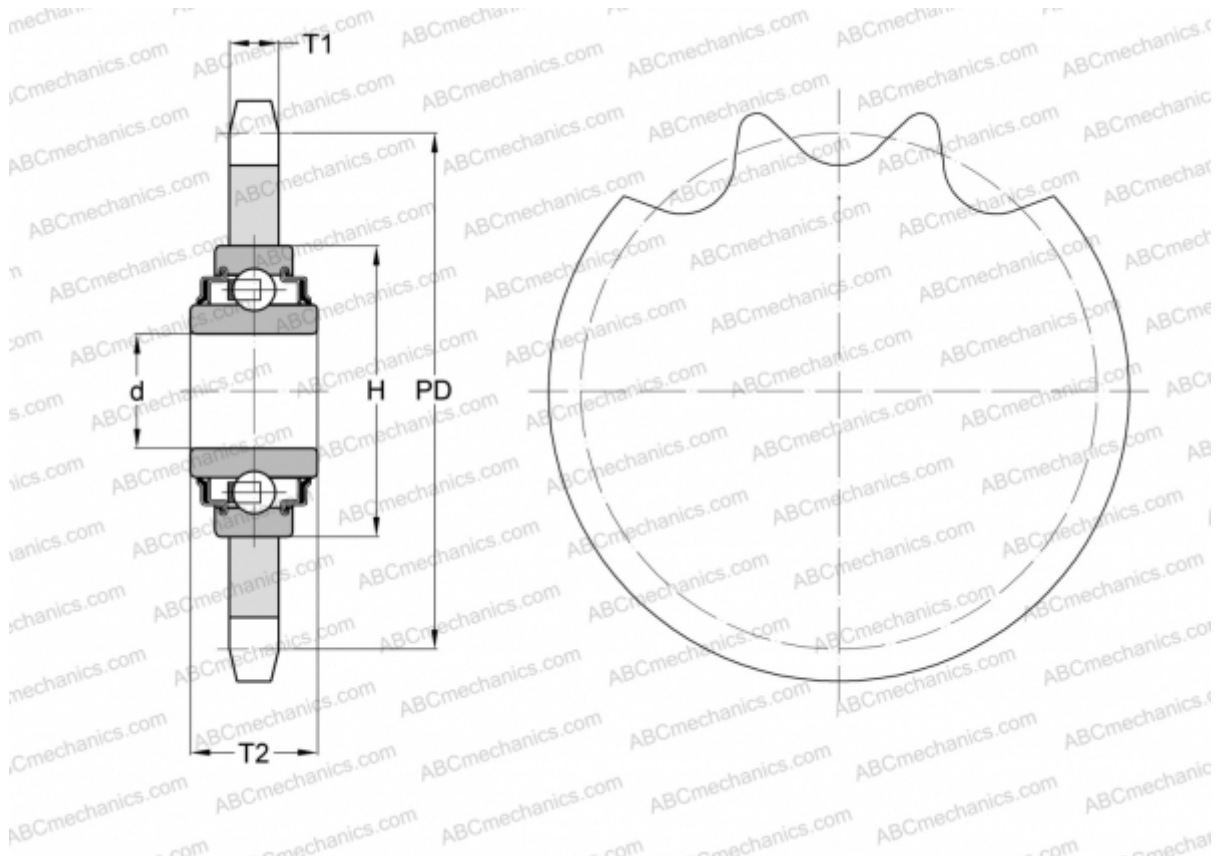

Technical specification

DIMENSIONS, MM

Pitch, p	9,525
Pitch diameter, PD	60,900
Dimensions bore, min	16,200
Dimensions bore, max	16,200
Hub, H	40,000
Thickness, T1	5,200
Thickness, T2	18,300
Number of teeth	20

WEIGHT, KG 0,140

MANUFACTURER [INA](http://www.ina.com)