

KSR16-LO-08-10-18-16 INA

Roller chain idler sprocket unit

TYPE: Simplex, Roller chain idler sprocket units, Sprocket made from steel or sintered iron, type KSR...-LO (INA)

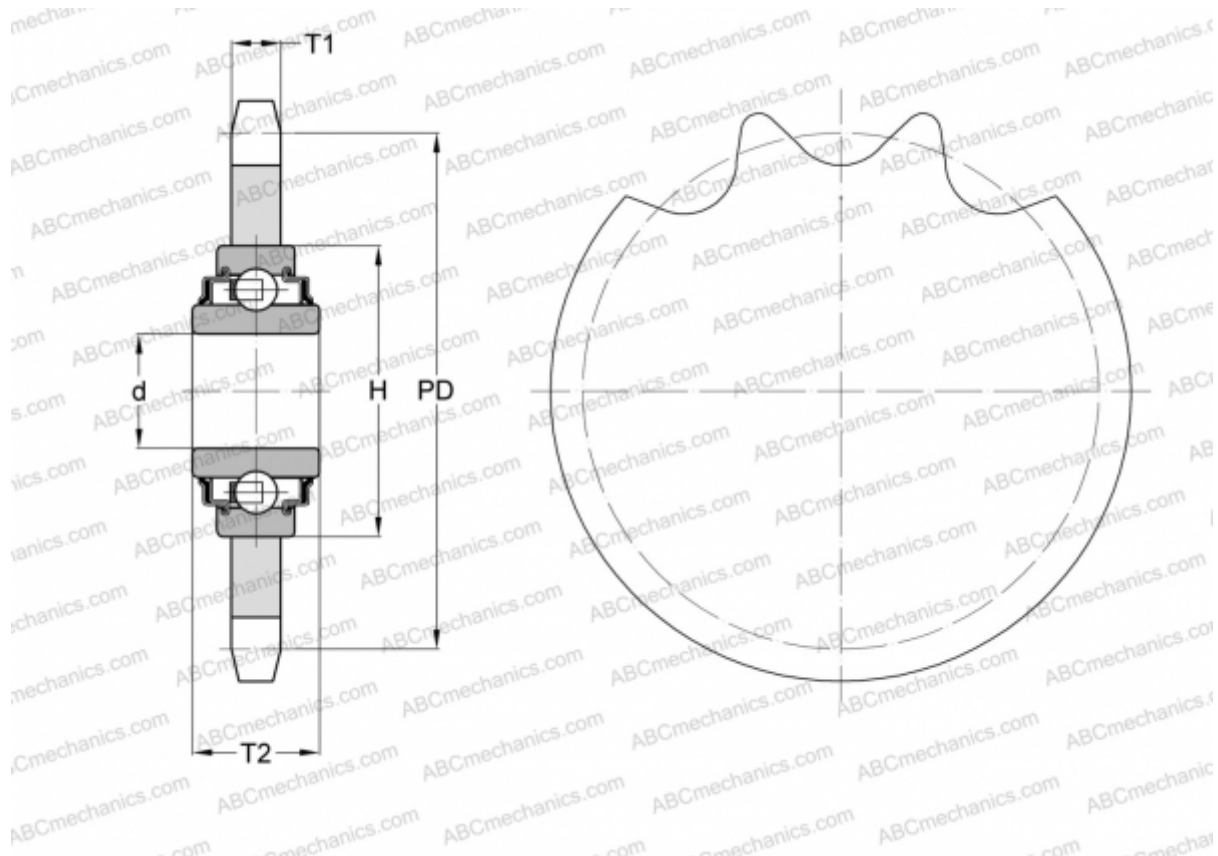

Technical specification

DIMENSIONS, MM

Pitch, p	12,700
Pitch diameter, PD	73,100
Dimensions bore, min	16,200
Dimensions bore, max	16,200
Hub, H	40,000
Thickness, T1	7,000
Thickness, T2	18,300
Number of teeth	18

WEIGHT, KG 0,210

MANUFACTURER [INA](http://www.ina.com)