

KSR20-B0-08-10-18-15 INA

Roller chain idler sprocket unit

TYPE: Simplex, Roller chain idler sprocket units, Sprocket made from steel or sintered iron, type KSR...-BO (INA)

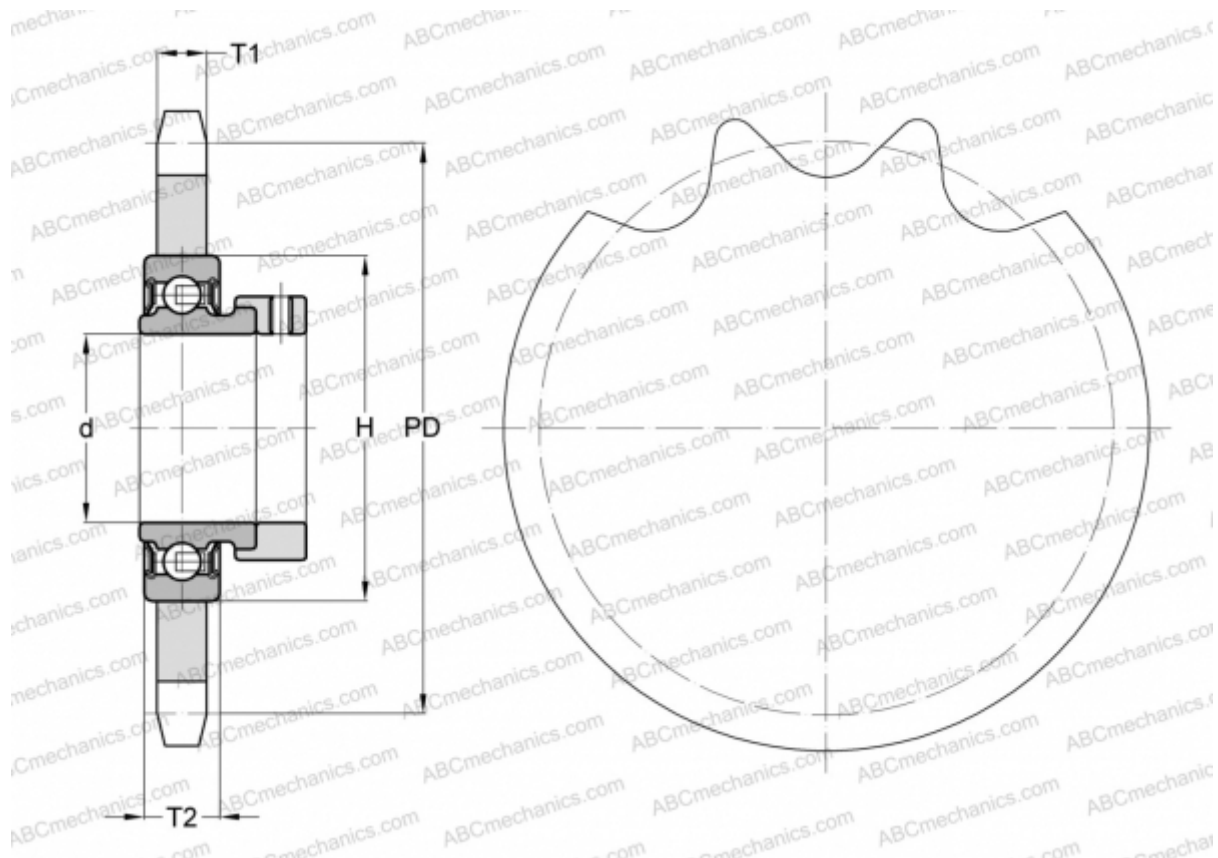

Technical specification

DIMENSIONS, MM

Pitch, p	12,700
Pitch diameter, PD	73,100
Dimensions bore, min	20,000
Dimensions bore, max	20,000
Hub, H	47,000
Thickness, T1	7,000
Thickness, T2	14,000
Number of teeth	18

WEIGHT, KG 0,320

MANUFACTURER [INA](#)