

KSR20-B0-16-10-10-15 INA

Roller chain idler sprocket unit

TYPE: Simplex, Roller chain idler sprocket units, Sprocket made from steel or sintered iron, type KSR...-BO (INA)

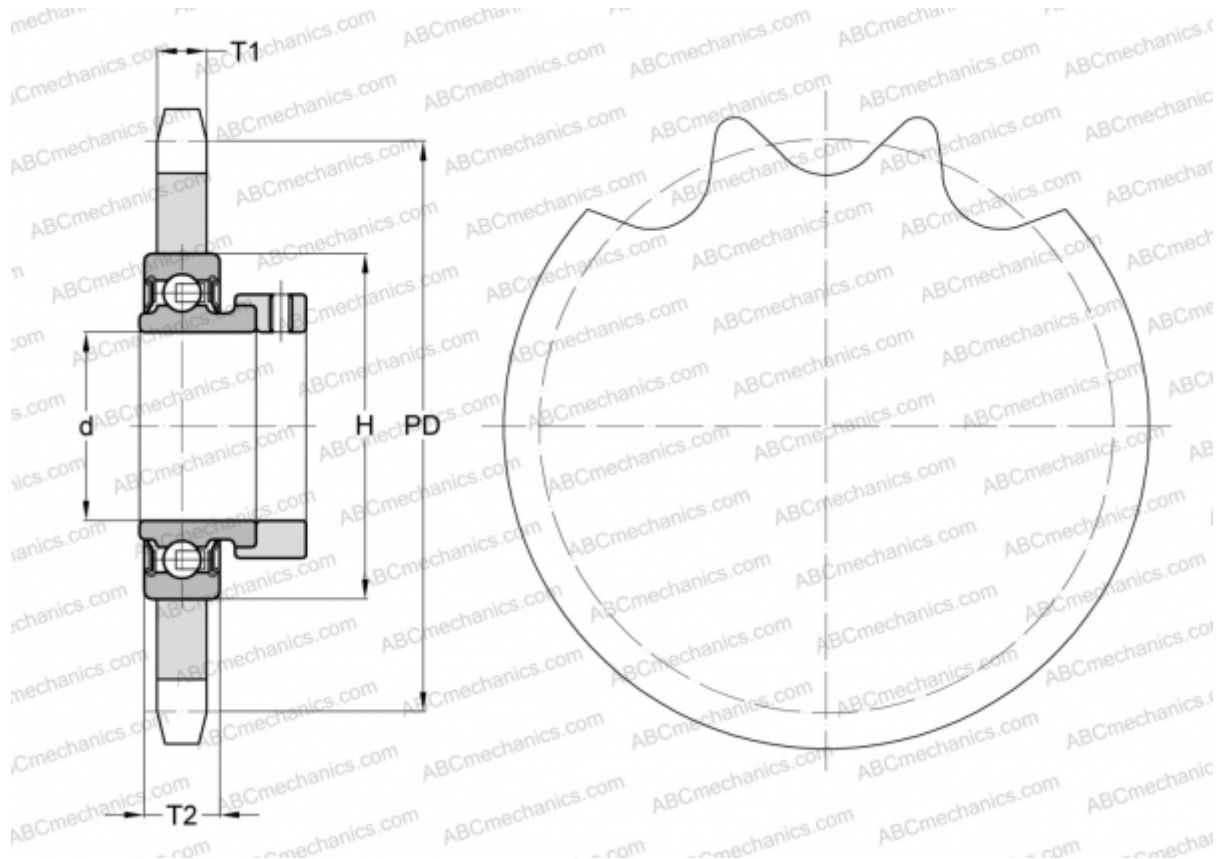

Technical specification

DIMENSIONS, MM

Pitch, p	25,400
Pitch diameter, PD	82,300
Dimensions bore, min	20,000
Dimensions bore, max	20,000
Hub, H	47,000
Thickness, T1	15,300
Thickness, T2	14,000
Number of teeth	10

WEIGHT, KG 0,500

MANUFACTURER [INA](#)