

## KSR16-L0-10-10-17-22 INA

Roller chain idler sprocket unit

TYPE: Simplex, Roller chain idler sprocket units, Sprocket made from polyamide, type KSR.-L0.-22 (INA)

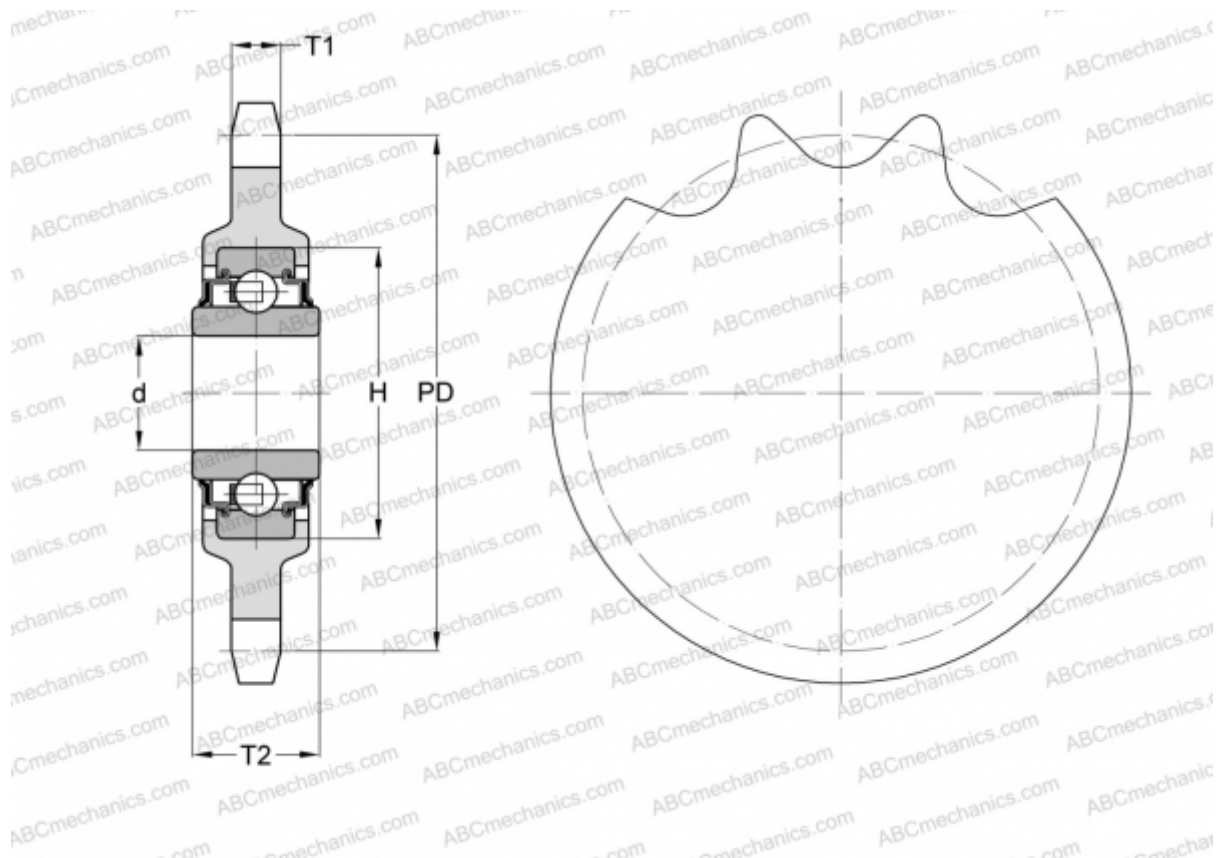

### Technical specification

#### DIMENSIONS, MM

Pitch, p	15,875
Pitch diameter, PD	86,400
Dimensions bore, min	16,200
Dimensions bore, max	16,200
Hub, H	40,000
Thickness, T1	8,700
Thickness, T2	18,300
Number of teeth	17

**WEIGHT, KG** 0,260

**MANUFACTURER** [INA](https://www.ina.com)