

PHS 08B-2TB68 SKF

Metric sprockets

TYPE: Double simplex, Taper bushed, hub on two side, Standard BS/ISO (SKF)

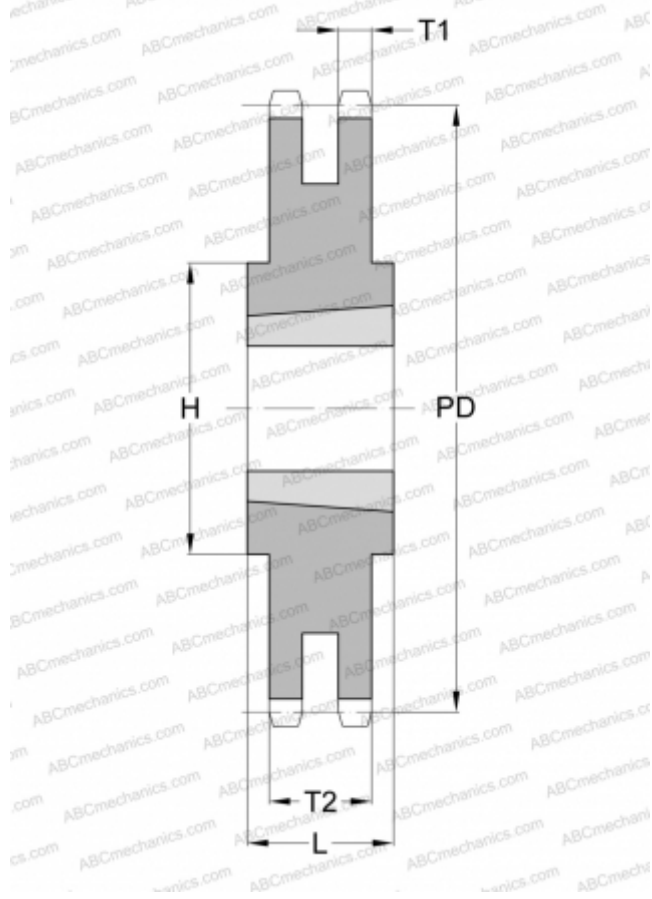

Technical specification

DIMENSIONS, MM

Pitch, p	12,700
Pitch diameter, PD	274,990
Dimensions bore, min	16,000
Dimensions bore, max	63,500
Hub, H	100,000
Thickness, T1	7,240
Thickness, T2	21,130
Number of teeth	68
Number of sleeve	2517

WEIGHT

Weight, kg	4,330
Weight sleeve, kg	1,300

MANUFACTURER

[SKF](#)