

PHS 40-2TB48 SKF

ANSI sprockets

TYPE: Double simplex, Taper bushed, hub on two side, Standard ANSI (SKF)

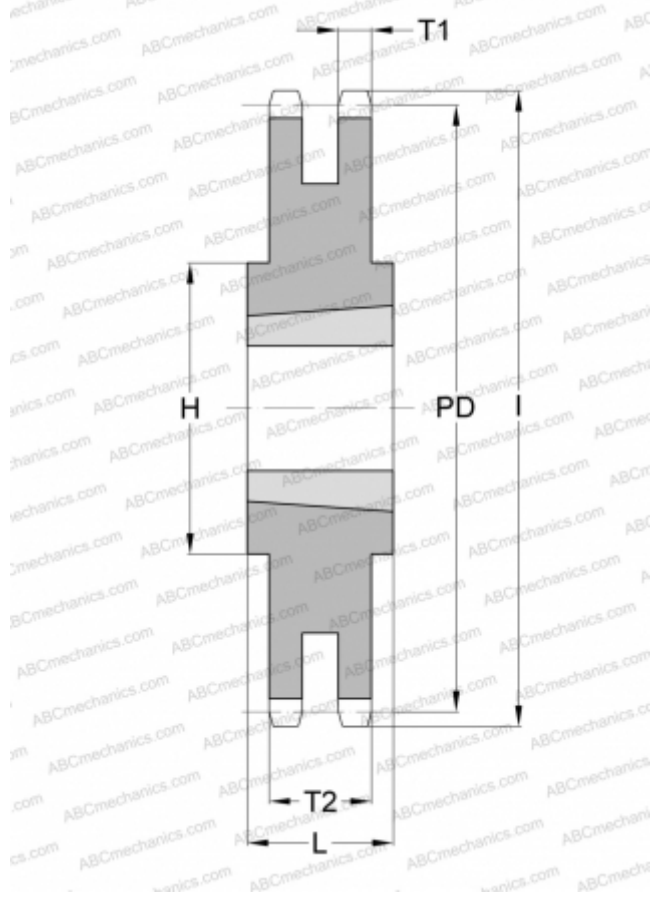

Technical specification

DIMENSIONS, MM

Pitch, p	12,700
Pitch diameter, PD	194,183
Dimensions bore, min	19,050
Dimensions bore, max	63,500
Hub, H	107,950
Thickness, T1	6,990
L	201,371
Number of teeth	48
Number of sleeve	2517

WEIGHT

Weight, kg	9,600
Weight sleeve, kg	3,500

MANUFACTURER

[SKF](#)