

PHS 40-2TB52 SKF

ANSI sprockets

TYPE: Double simplex, Taper bushed, hub on two side, Standard ANSI (SKF)

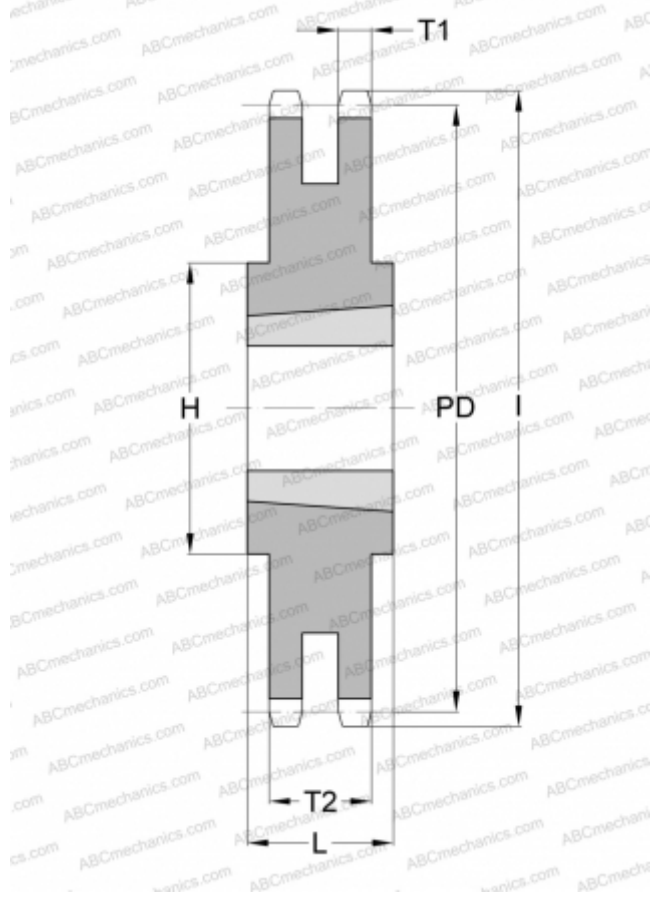

Technical specification

DIMENSIONS, MM

Pitch, p	12,700
Pitch diameter, PD	210,337
Dimensions bore, min	19,050
Dimensions bore, max	63,500
Hub, H	107,950
Thickness, T1	6,990
l	217,576
Number of teeth	52
Number of sleeve	2517

WEIGHT

Weight, kg	11,400
Weight sleeve, kg	3,500

MANUFACTURER

[SKF](#)