

## PHS 40-2TB84 SKF

ANSI sprockets

TYPE: Double simplex, Taper bushed, hub on two side, Standard ANSI (SKF)

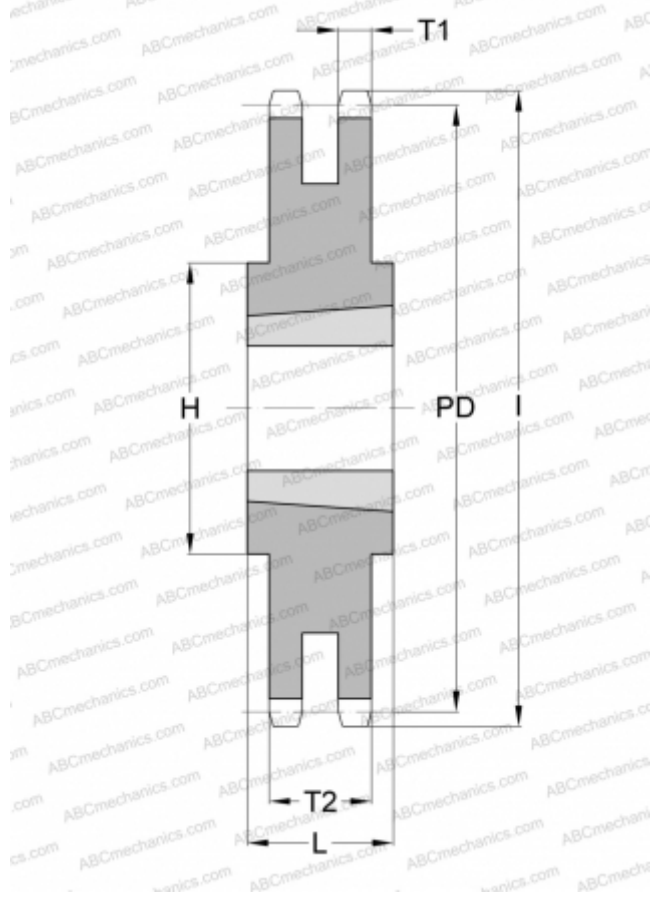

### Technical specification

#### DIMENSIONS, MM

Pitch, p	12,700
Pitch diameter, PD	339,649
Dimensions bore, min	19,050
Dimensions bore, max	63,500
Hub, H	107,950
Thickness, T1	6,990
L	347,040
Number of teeth	84
Number of sleeve	2517

#### WEIGHT

Weight, kg	31,600
Weight sleeve, kg	3,500

#### MANUFACTURER

[SKF](#)