

PHS 60-2TB68 SKF

ANSI sprockets

TYPE: Double simplex, Taper bushed, hub on two side, Standard ANSI, type C1 (SKF)

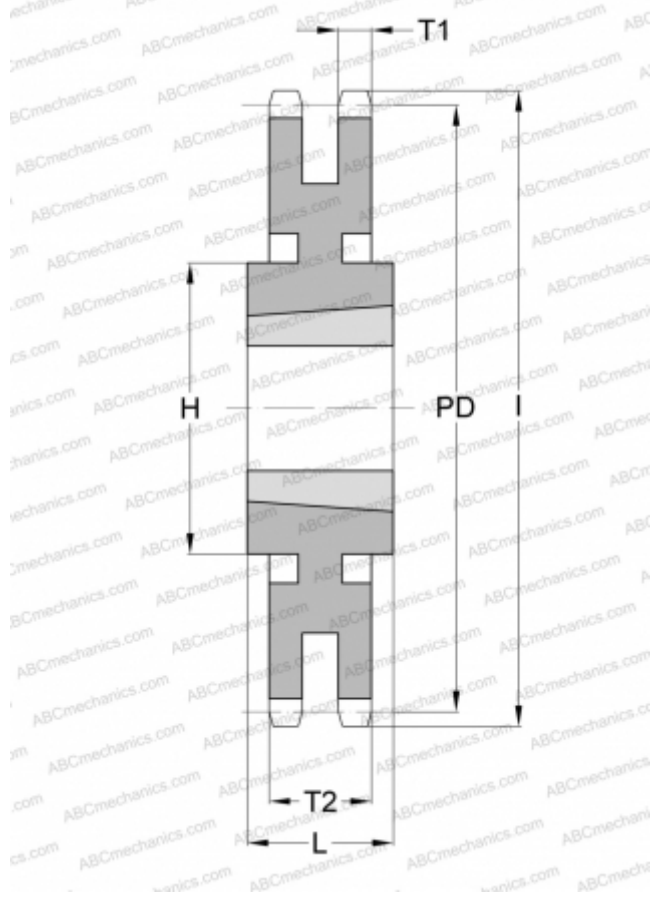

Technical specification

DIMENSIONS, MM

Pitch, p	19,050
Pitch diameter, PD	412,496
Dimensions bore, min	19,050
Dimensions bore, max	38,100
Hub, H	114,300
Thickness, T1	11,280
L	423,469
Number of teeth	68
Number of sleeve	2517

WEIGHT

Weight, kg	36,500
Weight sleeve, kg	43,200

MANUFACTURER

[SKF](#)