

PHS 80-2TB76 SKF

ANSI sprockets

TYPE: Double simplex, Taper bushed, hub on two side, Standard ANSI, type C1 (SKF)

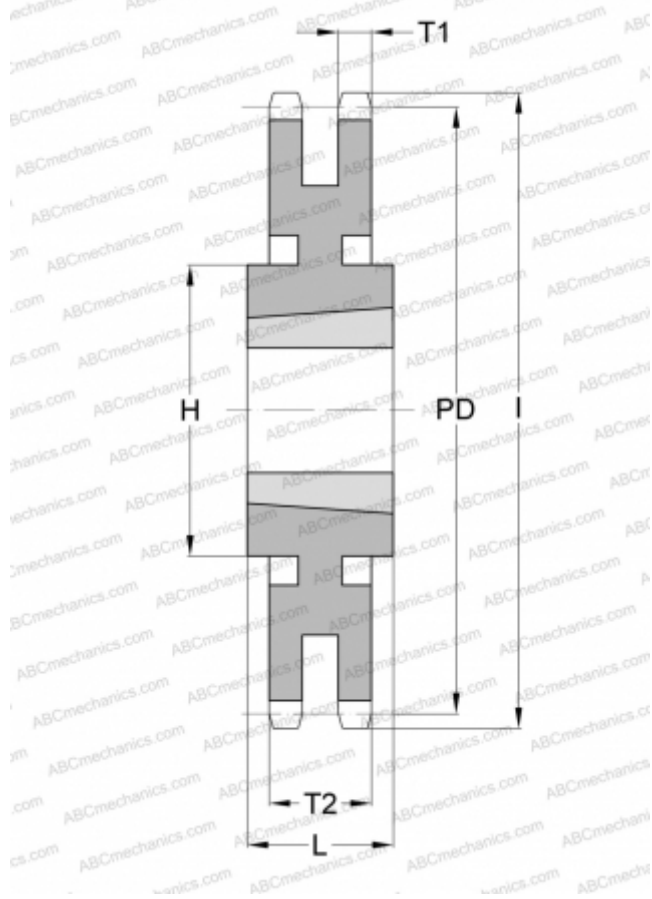

Technical specification

DIMENSIONS, MM

Pitch, p	25,400
Pitch diameter, PD	614,629
Dimensions bore, min	31,750
Dimensions bore, max	76,200
Hub, H	133,350
Thickness, T1	14,180
L	629,361
Number of teeth	76
Number of sleeve	3020

WEIGHT

Weight, kg	89,100
Weight sleeve, kg	6,500

MANUFACTURER

[SKF](#)