

## PHS 10B-3C95 SKF

Metric sprockets

TYPE: Triplex, Pilot bore, hub on two side, Standard BS/ISO (SKF)

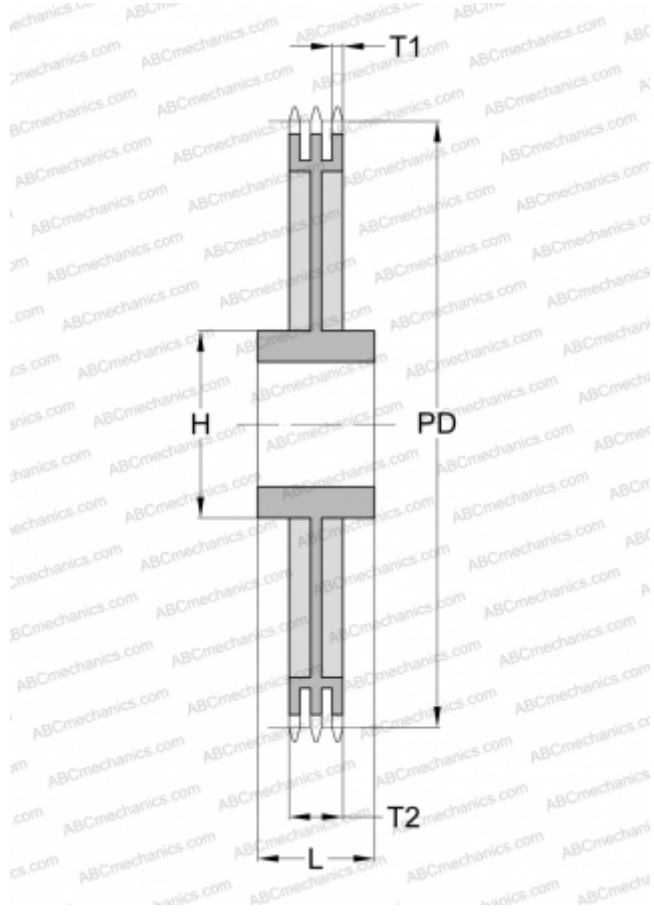

### Technical specification

#### DIMENSIONS, MM

Pitch, p	15,880
Pitch diameter, PD	480,140
Dimensions bore, min	25,000
Dimensions bore, max	80,000
Hub, H	130,000
Thickness, T1	8,970
Thickness, T2	42,140
Number of teeth	95

#### WEIGHT, KG

32,660

#### MANUFACTURER

[SKF](#)