

PHS 12B-3C95 SKF

Metric sprockets

TYPE: Triplex, Pilot bore, hub on two side, Standard BS/ISO (SKF)

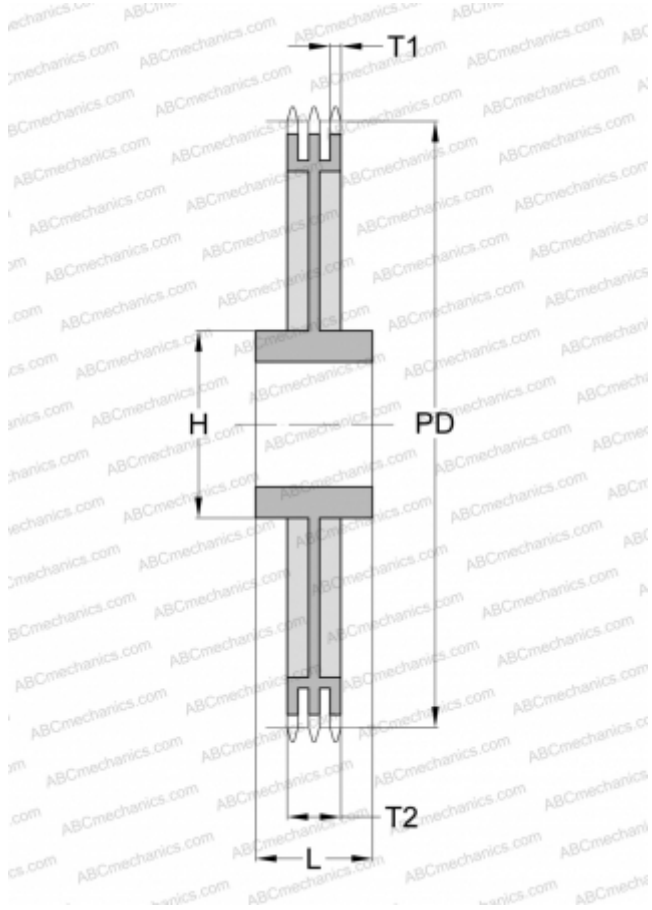

Technical specification

DIMENSIONS, MM

Pitch, p	19,050
Pitch diameter, PD	576,170
Dimensions bore, min	25,000
Dimensions bore, max	95,000
Hub, H	140,000
Thickness, T1	10,870
Thickness, T2	49,780
Number of teeth	95

WEIGHT, KG

47,630

MANUFACTURER

[SKF](#)