

PHS 50-3C102 SKF

ANSI sprockets

TYPE: Triplex, Pilot bore, hub on two side, Standard ANSI (SKF)

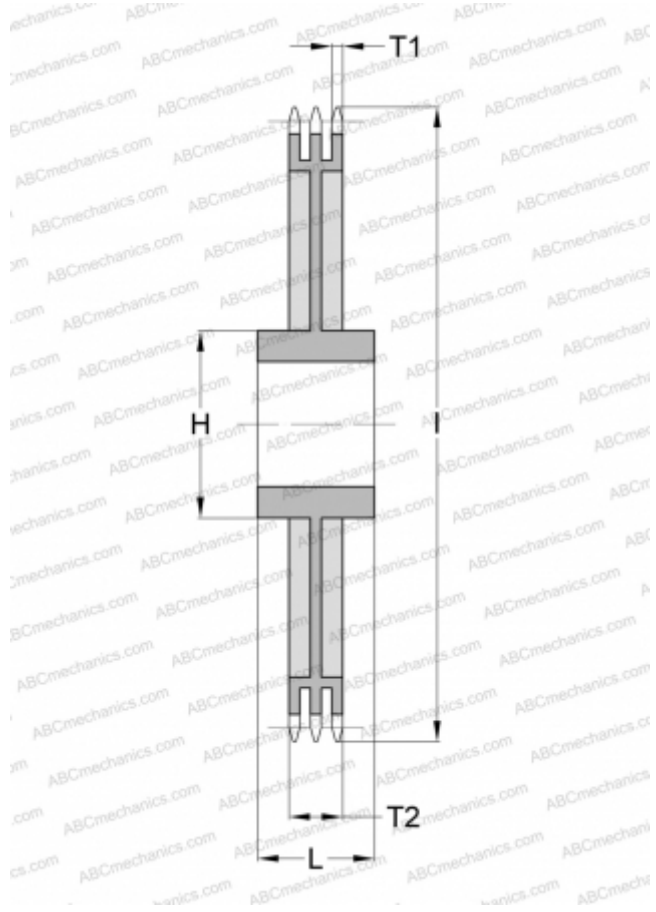

Technical specification

DIMENSIONS, MM

Pitch, p	15,875
Dimensions bore, min	33,337
Dimensions bore, max	76,200
Hub, H	120,650
Thickness, T1	8,430
l	524,764

WEIGHT, KG

79,940

MANUFACTURER

[SKF](#)