

PHS 12B-3TB30 SKF

Metric sprockets

TYPE: Triplex, Taper bushed, hub on one side, Standard BS/ISO (SKF)

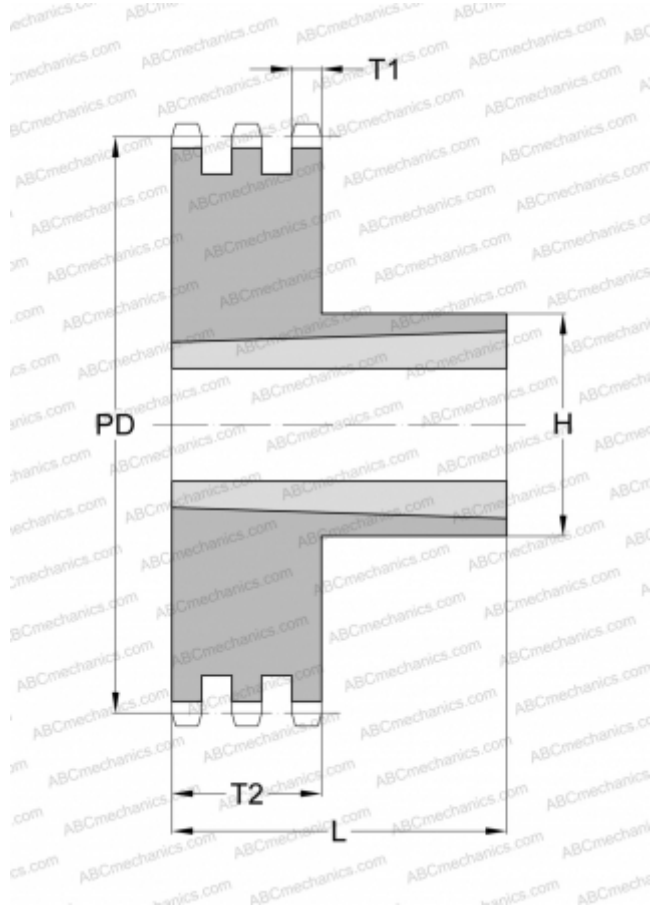

Technical specification

DIMENSIONS, MM

Pitch, p	19,050
Pitch diameter, PD	182,250
Dimensions bore, min	25,000
Dimensions bore, max	75,000
Hub, H	51,000
Thickness, T1	10,870
Thickness, T2	49,780
Number of teeth	30
Number of sleeve	3020

WEIGHT, KG

5,720

MANUFACTURER

[SKF](#)