

PHS 16B-3TB21 SKF

Metric sprockets

TYPE: Triplex, Taper bushed, hub on one side, Standard BS/ISO (SKF)

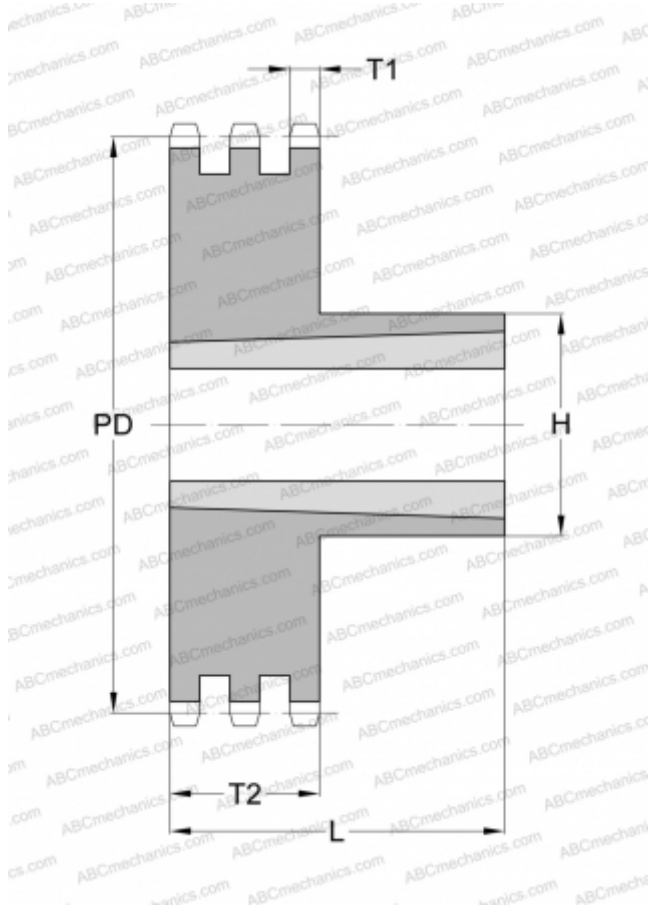

Technical specification

DIMENSIONS, MM

Pitch	25,400
Pitch diameter, PD	170,430
Dimensions bore, min	35,000
Dimensions bore, max	75,000
Hub, H	76,200
Thickness, T1	15,820
thickness, T2	79,580
Number of teeth	21
Number of sleeve	3020

WEIGHT, KG

6,600

MANUFACTURER

[SKF](#)