

PHS 16B-3TB25 SKF

Metric sprockets

TYPE: Triplex, Taper bushed, hub on one side, Standard BS/ISO (SKF)

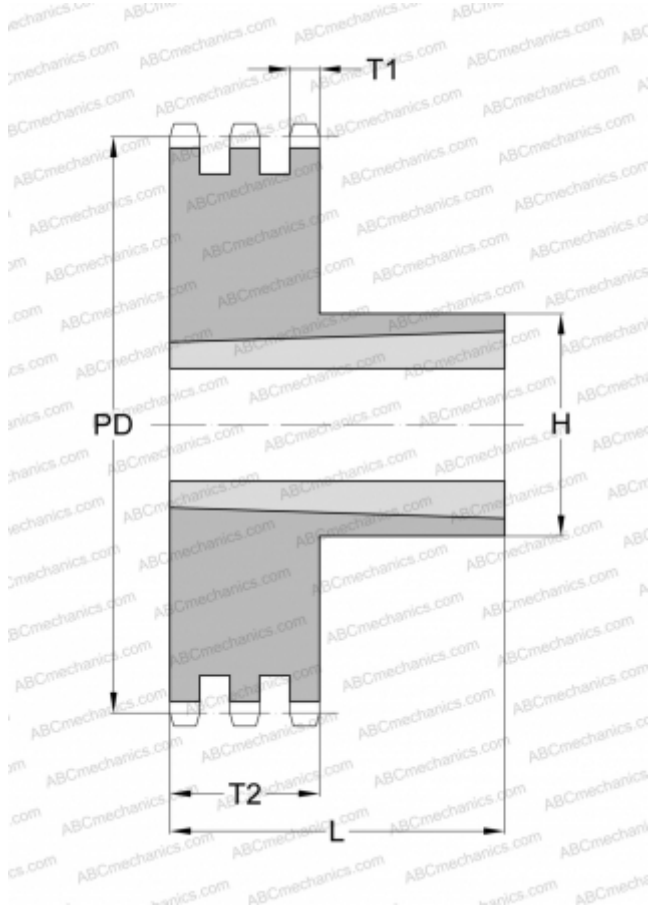

Technical specification

DIMENSIONS, MM

Pitch, p	25,400
Pitch diameter, PD	202,660
Dimensions bore, min	35,000
Dimensions bore, max	100,000
Hub, H	65,000
Thickness, T1	15,820
Thickness, T2	79,580
Number of teeth	25
Number of sleeve	3525

WEIGHT, KG

9,800

MANUFACTURER

[SKF](#)