

## PHS 05B-1A11 SKF

Metric sprockets

TYPE: Simplex, Pilot bore without hub, Standard BS/ISO (SKF)

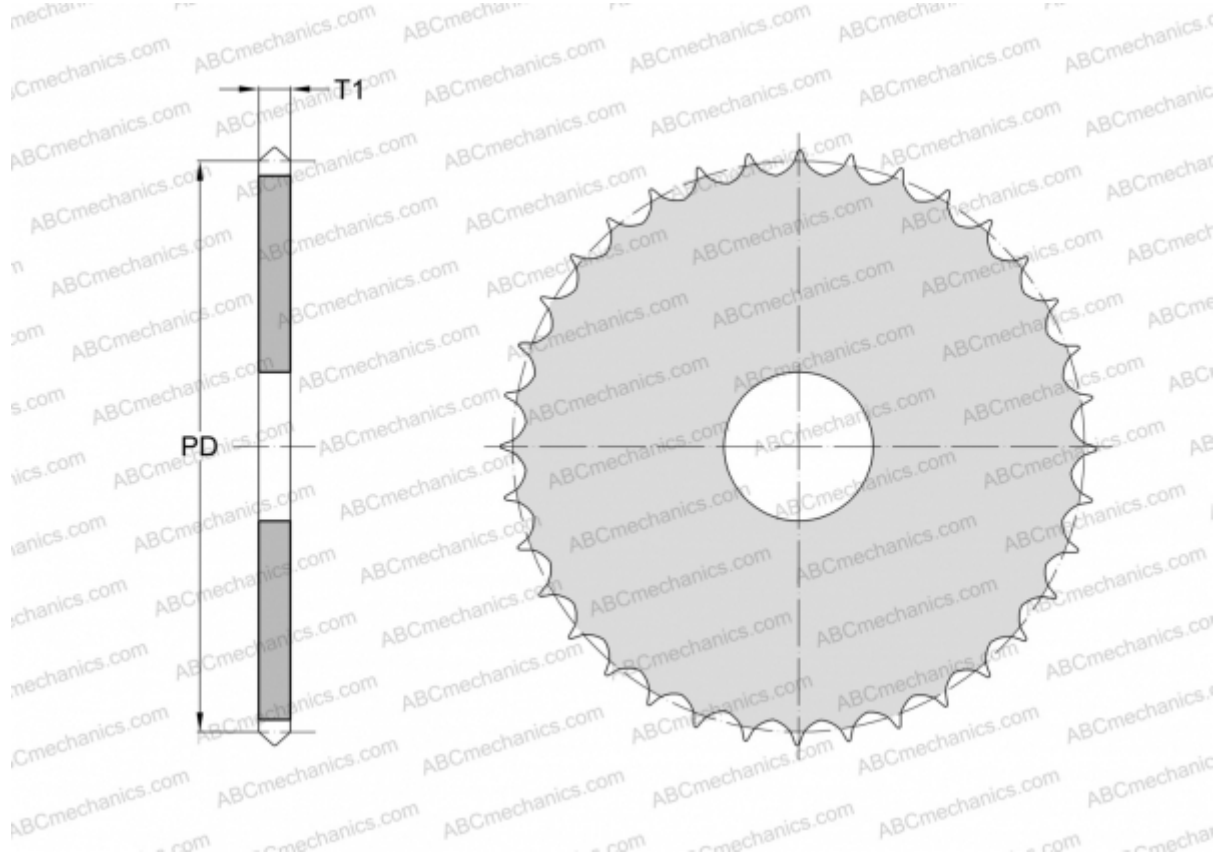

### Technical specification

#### DIMENSIONS, MM

Pitch, p	8,000
Pitch diameter, PD	28,390
Dimensions bore, min	8,000
Thickness, T1	2,800
Number of teeth	11

**WEIGHT, KG** 0,010

**MANUFACTURER** [SKF](#)