

PHS 05B-1A14 SKF

Metric sprockets

TYPE: Simplex, Pilot bore without hub, Standard BS/ISO (SKF)

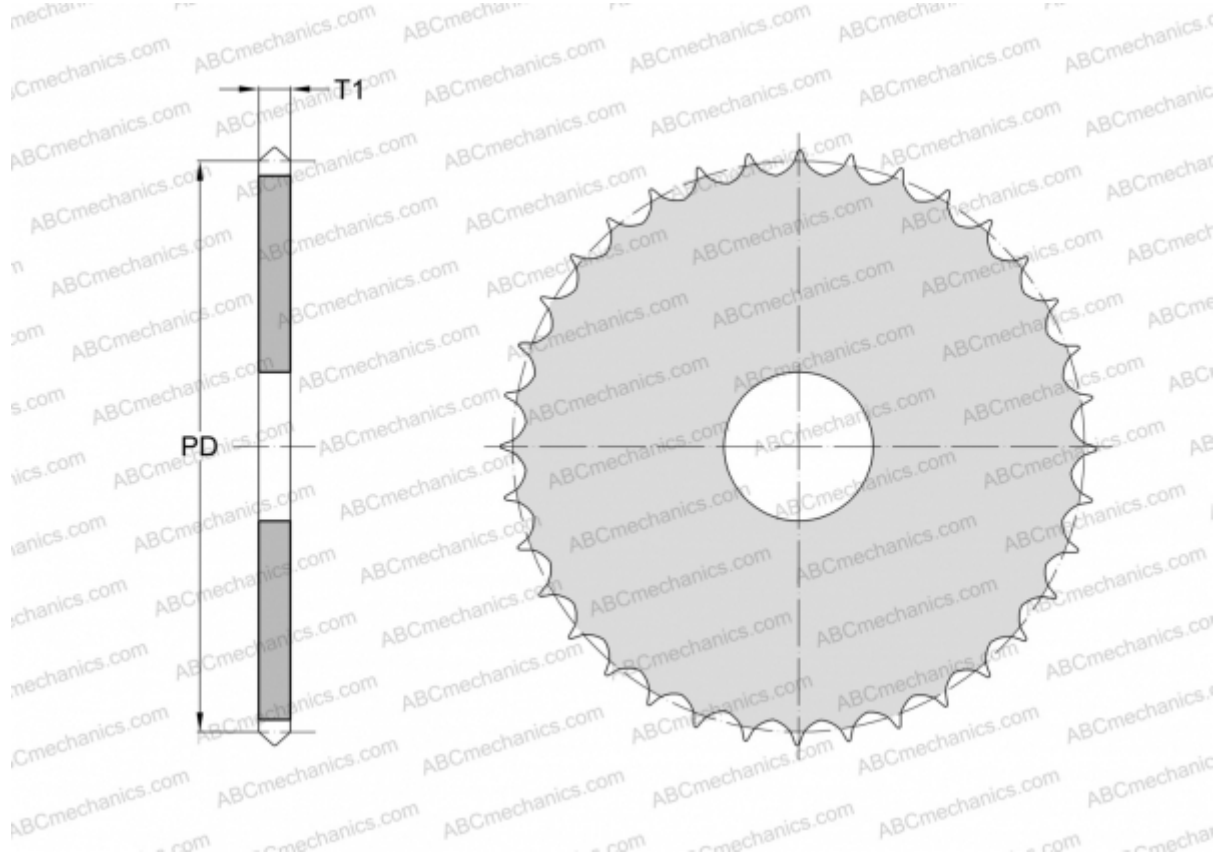

Technical specification

DIMENSIONS, MM

Pitch, p	8,000
Pitch diameter, PD	35,950
Dimensions bore, min	8,000
Thickness, T1	2,800
Number of teeth	14

WEIGHT, KG 0,020

MANUFACTURER [SKF](#)