

PHS 05B-1A18 SKF

Metric sprockets

TYPE: Simplex, Pilot bore without hub, Standard BS/ISO (SKF)

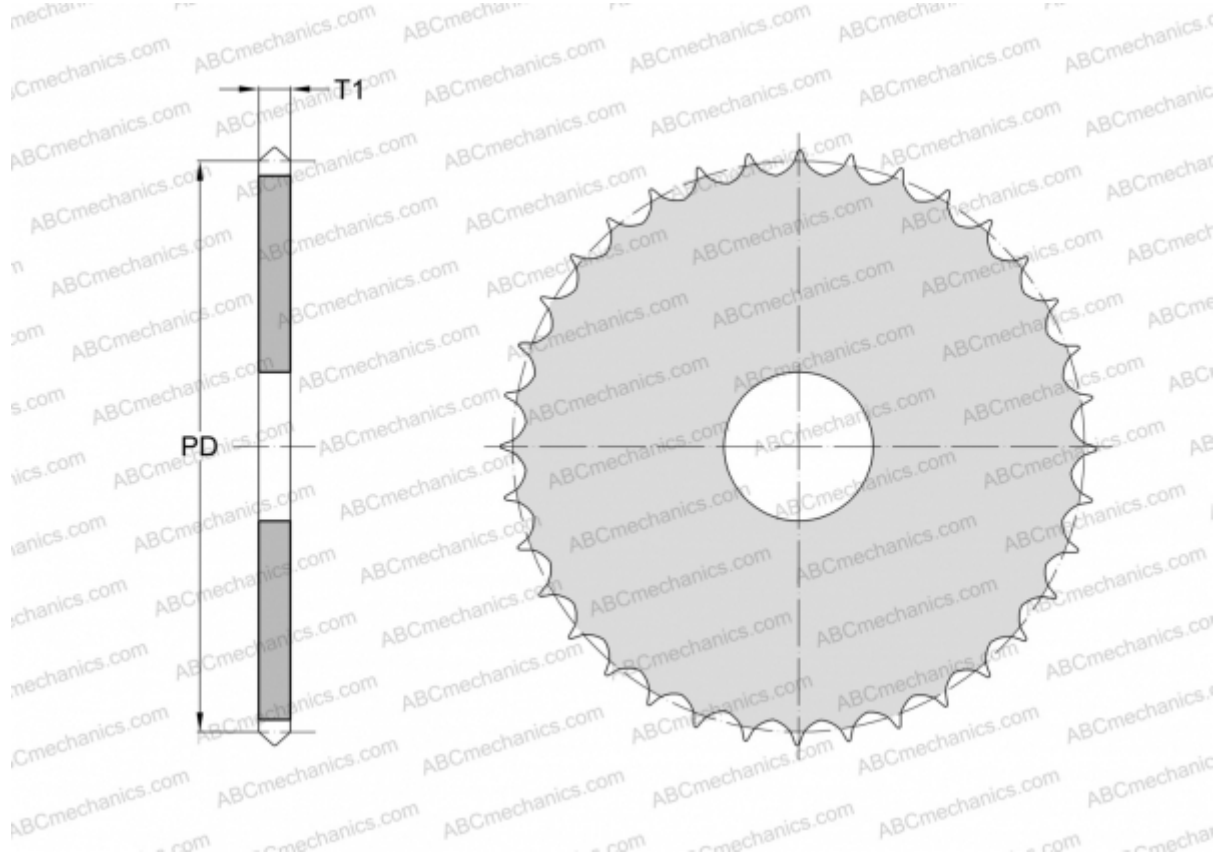

Technical specification

DIMENSIONS, MM

Pitch, p	8,000
Pitch diameter, PD	46,070
Dimensions bore, min	8,000
Thickness, T1	2,800
Number of teeth	18

WEIGHT, KG 0,030

MANUFACTURER [SKF](#)