

## PHS 100-1A17 SKF

ANSI sprockets

TYPE: Simplex, Pilot bore without hub, Standard ANSI (SKF)

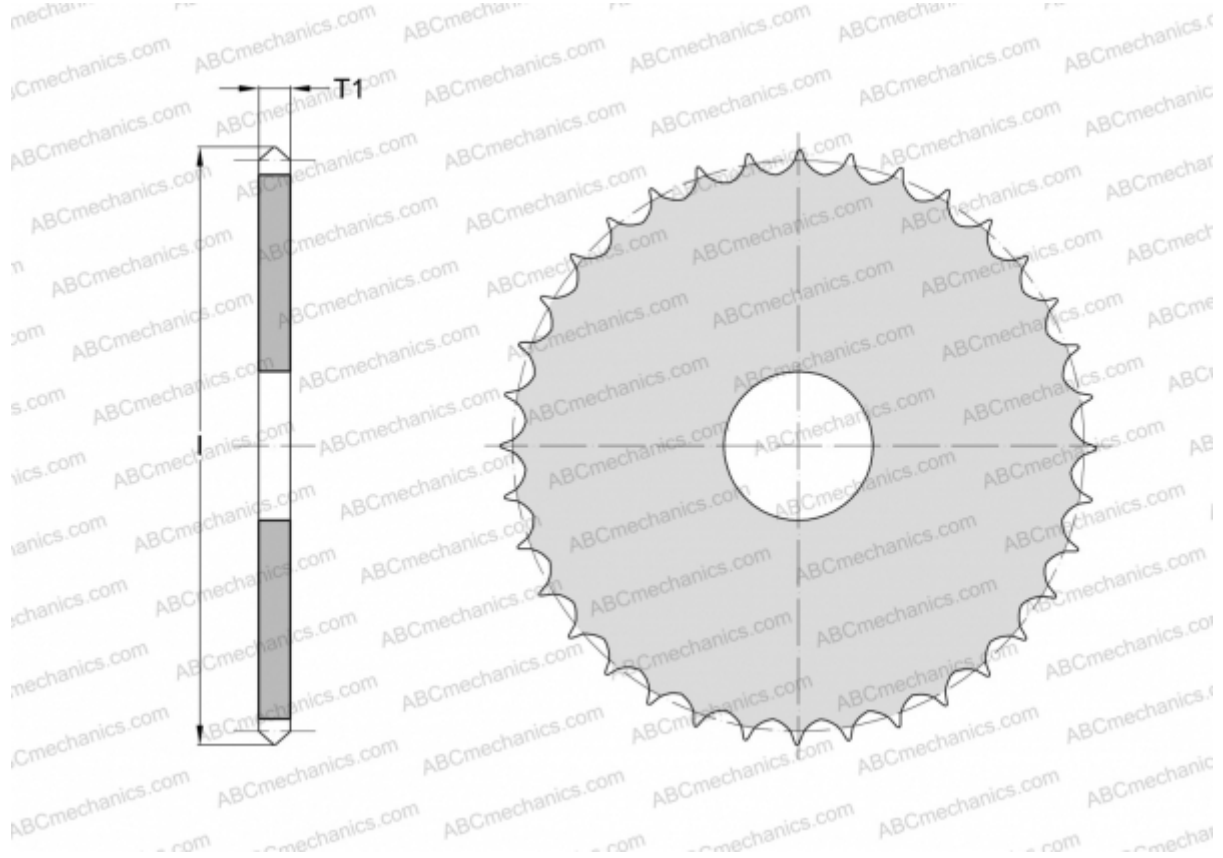

### Technical specification

#### DIMENSIONS, MM

Pitch, p	31,750
Dimensions bore, min	31,750
Thickness, T1	17,570
l	188,976
Number of teeth	17

**WEIGHT, KG** 2,745

**MANUFACTURER** [SKF](#)